

**CARROT 3 BOOSTER SEAT - CHILD RESTRAINT SYSTEM**  
For Children with Special Needs

**Instruction Manual**

**Convaid**  
**CARROT**  
**3**



**WARNING**

Read all instructions  
before using this  
restraint system.



## **CARROT 3 CHILD RESTRAINT SYSTEM**

The Carrot 3 Booster Seat is an extended version of the standard Carrot 3 child restraint system. The Carrot 3 Booster Seat offers a larger configuration to meet the needs of children that require additional seat growth that is not available on the standard Carrot 3. Always consult your doctor to make sure that this restraint system is suitable for your child.

Your child's safety is very important to us. To ensure that your restraint system is installed correctly, please read all the instructions in this manual before using. If you require additional assistance, please call Convoid at 1-844-US-Mobility (844-876-6245).

Sole importer in Americas:

Convoid  
2830 California Street  
Torrance, CA 90503  
Phone: 1-844-US-Mobility (844-876-6245)  
Fax: 310-618-2166

## Table of Contents

<b>Warnings</b>	4
<b>Safety Information</b>	6
Important Notes	6
Certification	7
<b>Features</b>	8
<b>Installation</b>	9
<b>LATCH Installation</b>	9
<b>Functions</b>	11
<b>Head Support</b>	11
Head Support Depth Adjustment	11
Head Support Contour Adjustment	11
Head-Pillow Adjustment	11
<b>Shoulder Support</b>	12
Shoulder Width Adjustment	12
Padded Covers	12
<b>Backrest</b>	13
Backrest Height Adjustment	13
<b>4-Point H-Harness</b>	13
Fastening / Releasing Harness Buckle	13
Seat Depth Adjustment	14
<b>Accessories</b>	15
Support Tray	15
Seat Wedge	15
4" Backrest Extensions (100mm)	15
3D Body Balance Pads	15
Crotch Belt for XL/Booster Seat only	16
<b>Securing Your Child</b>	17
<b>Care and Maintenance</b>	20
Cleaning the Cover, Pillow and Pads	20
Harness & Straps	20
<b>Product Dimensions</b>	21
<b>Warranty</b>	22

**WARNING!**

DEATH or SERIOUS INJURY can occur

- Recommended for use with children who have outgrown the Carrot 3 car seat. Suggested guidelines are children who weigh more than 79lbs (36kg) and less than 165lbs (75kg) with height between 57" (145 cm) and 70" (180 cm). It has been successfully crash tested.
- Use in forward-facing only.
- Never alter construction of the Carrot 3 Booster Seat child, unless specially authorized in the instruction manual.
- Adjust the belts provided with this child seat so they fit snugly around your child. A snug strap should not allow any slack or twist. It does not press on the child's skin or push the child's body into an unnatural position.
- Secure child restraint system with the upper and lower fixing straps to the vehicle's seat, and always use vehicle's lap shoulder 3-point safety belts as well.
- Fasten the harness 4-point of the child restraint system as well as the vehicle's lap shoulder 3-point safety belt to secure your child in a firm position.
- Follow all the instructions on this child restraint system and in this instruction manual.
- Use this child restraint only with vehicles with lap shoulder 3-point safety belts approved by FMVSS 209.
- The rigid items and plastic parts of the child restraint system must be located and installed in a way so they don't become trapped by a movable seat or in a door of the vehicle.
- To prevent injury due to hidden damage, discontinue use of a child restraint system that has been in any type of car crash.
- This child restraint system must be used with the cover.

**WARNING!****DEATH or SERIOUS INJURY can occur**

- The child restraint system cover should only be replaced with the one recommended by the manufacturer.
- This instruction manual should be stored in the pocket on the back of the child restraint system.
- This child restraint system is not for use in the home, in boats, or other non-certified applications.
- The back seat of vehicle is the safest location for a properly installed child restraint system. Please comply with the safety standards in your vehicle owner's manual, to ensure your child's safety.
- Secure this child restraint system seat even when it is not occupied. In a crash, an unsecured child seat may injure vehicle occupants.
- When using in a vehicle with airbags, refer to your vehicle's owner's manual for child restraint system installation instructions and precautions.
- Never use the adjuster strap to lift or carry this child restraint system. Doing so will cause damage to the harness adjuster and webbing. Always carry this child restraint system by its shell.
- Do not take the child restraint system apart or attempt to take apart the harness and the straps from the child seat. Do not remove the buckles and/ or the buckle tongues from the harness or the straps. They cannot be reattached after removal. If reassembled incorrectly, the child restraint system may not perform optimally.
- The primary protection for occupants of a vehicle in a collision is the body of the vehicle itself; a child restraint system will not protect a child when a vehicle is seriously impacted. However, correctly installed, a child restraint system will substantially improve chances for survival in most crashes. Make sure all users fully understand proper use of this child restraint system in a vehicle.

## Safety Information

### Important Notes

Correctly set up and install the child restraint before using. Before each use, verify it is securely installed to the vehicle seat and the harness is properly adjusted around child.

- Adjust harness to fit securely around the clothes the child is wearing. Remove bulky coats and/or jackets before putting child in restraint system.
- Cover child restraint when vehicle is parked in direct sunlight. Parts of the restraint could become hot and cause injury to a child.
- Store restraint in a safe place when not in use. Avoid placing heavy objects on top of it.
- Never leave children alone in a vehicle, even for a short time.
- Do not attempt to disassemble any part of the child restraint or change the way its harness or vehicle's seat belts are used, except as described in this manual.
- Do not leave loose objects, e.g. books, bags, etc., in the back of a vehicle. In the event of a sudden stop, loose objects will keep moving, potentially causing serious injuries.
- Make sure vehicle seats that fold forward are securely locked in the upright position.
- An unsecured vehicle seat back could prevent the restraint from protecting the child completely.
- Do not use anything to raise child seat off vehicle seat except as described in this manual. In an accident, the child restraint may not adequately protect the child.
- Do not allow children to play with this or any child restraint system.
- This child seat is recommended to be used in the upright position.

### Certification

This child restraint system is designed for occupants who weigh more than 79 lbs (36 kg) and less than 165 lbs (75 kg)



#### **WARNING!**

This child restraint must be used in a forward-facing position only.



#### **WARNING!**

Before reclining the back, you must release and loosen the harness straps. Once reclined, re-tighten the harness straps. Reclining the back without loosening the harness straps may cause choking.

The Carrot 3 was tested at a 30° recline from vertical, and should not be transported in a moving vehicle past this point.

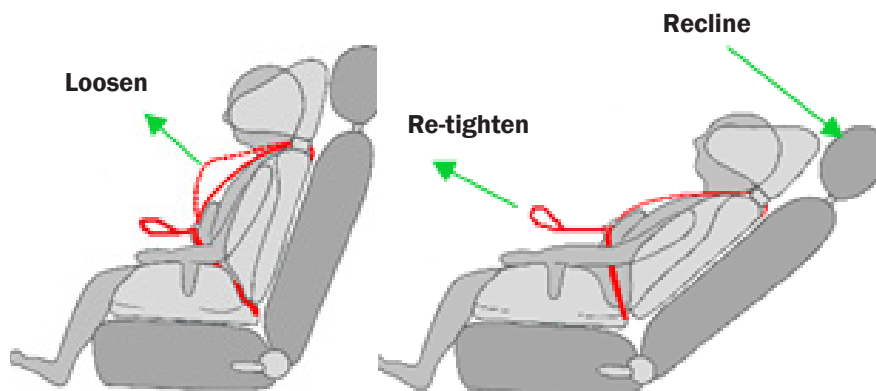

# Features

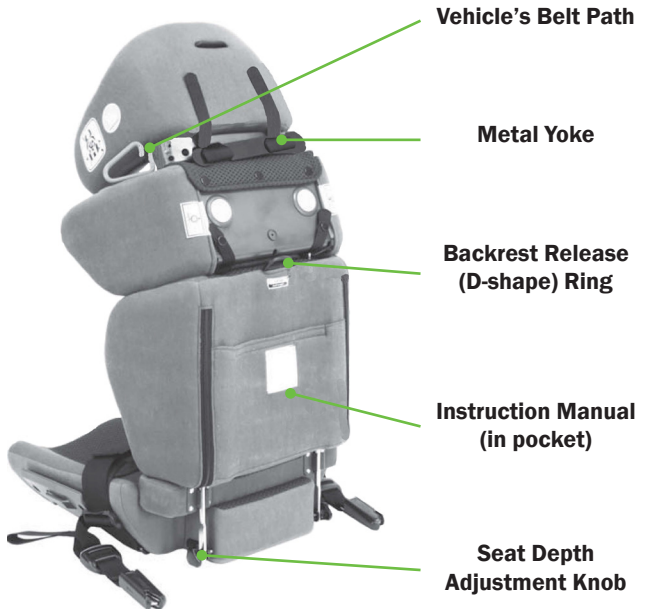



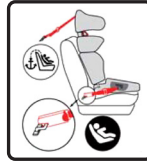

## LATCH Installation

This child restraint system is recommended for use in a vehicle with LATCH anchors. Verify that your vehicle is equipped with LATCH anchors.

Lower Anchor Straps Installation:

1. Press and hold the first LATCH adjuster release button, then pull the LATCH strap to full length. Repeat for the remaining LATCH connector (**Fig. A**).
2. Place the child restraint forward-facing on the vehicle seat.
3. Attach one LATCH connector to its adjacent vehicle LATCH anchor (**Fig. B**).
  - a. An audible click confirms attachment
  - b. Ensure that the LATCH strap is not twisted.
4. Attach the remaining LATCH connector to its adjacent vehicle LATCH anchor.
  - a. An audible click confirms attachment
  - b. Ensure that the LATCH strap is not twisted.
5. Push the child restraint into the vehicle seat while pulling each LATCH strap tight (**Fig. C**).



Fig. A

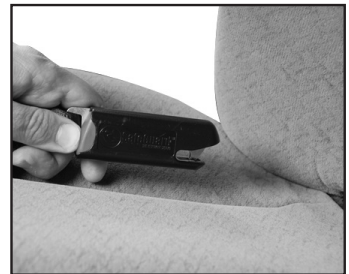

Fig. B



Fig. C

### NOTE:

If an audible click is not heard when connecting either LATCH connector, the LATCH strap may be twisted, or there may be debris in the LATCH connector. Correct either situation before continuing with the installation process.

### IMPORTANT:

Ensure the LATCH strap does not fold into the LATCH adjuster while tightening.

## Installation

### USING LATCH Top Tether Strap

If your vehicle is equipped with LATCH Top Tether Anchor points, you can use the Top Tether Strap to attach the Head Support.

#### NOTE:

All vehicles manufactured since September 1, 2002 are equipped with tether anchors located behind the rear seats.

1. Consult your vehicle owner's manual to locate the tether anchor points.
2. Pull and fully extend the top tether strap (**Fig. A** or **B**).
3. Locate the hook on the strap and loosely attach the tether strap to the anchor point.
4. Pull the tether strap to remove ALL slack (**Fig. B**).
5. Make sure the tether strap is taut and that the child seat is properly secured.



**Fig. A** (Car)



**Fig. B** (Van)

#### NOTE:

The child restraint is secure when it cannot be moved front-to-back or side-to-side more than 1 inch (2.5 cm) at the belt path. If the child restraint is not secure, repeat the installation process or use an alternate seating location.

## Head Support

### Head Support Depth Adjustment

The Head Support can be adjusted forward or backward by 0.6" (1.5 cm) increments to provide a better fit and added protection for the occupant (**Fig. A**).

To Adjust: Remove screws on each side of the head support with a Phillips screwdriver. Move the head support to selected position, and reinsert screws (**Figs. B & C**).



**Fig. A**

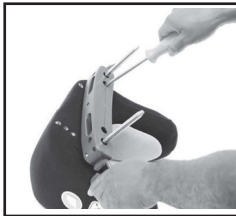

**Fig. B**

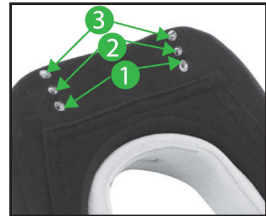

**Fig. C** (Use holes 1,2 or 3 on both sides)

### Head Support Contour Adjustment

The head support can be contoured to better fit and protect the head. This adjustment must be performed on limited bases (to not weaken the head support structure) by the dealer.



### Head Pillow Adjustment

The Head Pillow provides added comfort and positioning.

To reposition: Grasp the head pillow and pull it away from the head support. Place the head pillow where desired and press down to affix Velcro®.



## Functions

### Shoulder Support

#### Shoulder Width Adjustment

The Shoulder Protector wing can be extended by 4" (100mm), by extending the right and left sides by 2" (50 mm) each.

To extend the Shoulder Protector wing by 4" (100mm) you must move the wing to the fifth position. This is achieved by pressing on the yellow button on the back of the unit, while simultaneously pulling the wing outward toward you until it is in the desired position . Each position "stop" allows you to increase by approximately 0.5" (10mm).

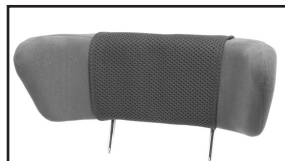

#### IMPORTANT

When your child becomes big enough to use the Shoulder Protector Wings, you can purchase the Shoulder Protector Wings for a larger child. You must contact and ask your dealer for the installation and adjustment of the set.

#### Padded Covers

You can adjust the Padded Covers favorable position by moving the Velcro® tape attached to the back of the Head-Support

**Note** Do not pull the Padded Covers on the harness strap as it is fixed on the back. Pull and loosen the harness strap only.



### Backrest Support

#### IMPORTANT

- The height of the Shoulder Harness Strap moves with the height of the Backrest.
- The level of the Shoulder Harness Strap must be at or above the occupant's shoulders, parallel to level ground.

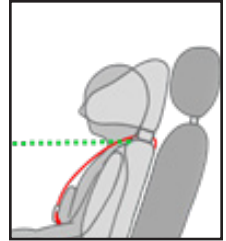

### Adjusting Backrest Height

Release the lock ring by pulling the Backrest Release (D-shape) ring on the back of the occupant child seat. While pulling the strap, adjust the height of the Backrest.



### 4-point H-Harness

#### Fastening / Releasing Harness Buckle

1. Hold the harness buckle with one hand. Use the other hand to insert the buckle tongue into the harness buckle (**Fig. A**).
2. Hold the harness buckle with one hand. Push and release the buckle tongues and slide out to remove from the buckle (**Fig. B**).



FIG.A



FIG.B

## Functions

### User's Seat Measure

#### Seat

To determine the appropriate seat depth for a user, the user should be placed in the best possible seated position that can be obtained. A measurement is taken from the back of the pelvis (furthest part of the buttocks), forward to the back of the knee. Make sure that each leg is measured separately. Deduct 2" from the measured length for clearance.

#### NOTE:

The seat depth should be slightly shorter than the length from pelvis to the rear of the knee.

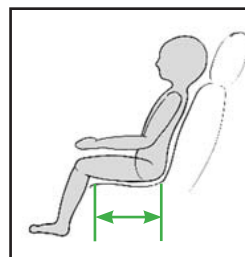

#### Seat Depth Adjustment

The seat depth is adjustable by 1.5" (40 mm). The factory setting is 16.5" (420 mm) to reduce seat depth to 15" (380 mm)

1. Remove the seat depth adjustment knobs.
2. Move the metal rods forward and reattach to the corresponding hole.

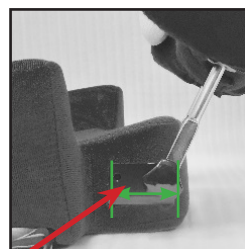

1.5" (40 mm)

Seat Depth Adjustment Knob

### Accessories

#### Support Tray

The X-Large support tray is designed specifically for the booster seat and may not be used to secure the child's upper limbs.



#### Seat Wedge

Use to increase and adjust the height and angle of the front area of the seat for better secure and stability of seating.

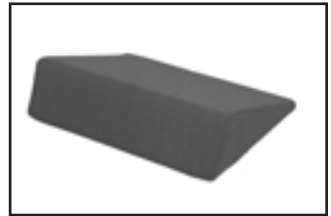

#### 4" Backrest Extension (100 mm)

Backrest Extension fills the space exposed between the backrest and the seat when you extend to the Backrest.



#### 3D Body Balance Pads

Ergonomic three-dimensional shaped pads for better positioning of the child's body.



## Functions

### Crotch Belt for XL/Booster Seat only

**ATTENTION:** This accessory is only adaptable to the latest version of XL/Booster seat which has a slit and holes in the center area of the seat and fabric.

1. Undo the seat cover partly by unfastening the Velcro® and zipper on the bottom.
2. Locate the two lower holes in the cushion.
3. To put the strap through the holes, it's easier to fold them to make it thinner.
4. Feed the straps through the top cover and through the bottom cushion lower two holes and pull them out from the bottom side.
5. Squeeze the crotch belt into the slit in the upper side of the cover, making sure the buckle of the crotch belt is facing forward.
6. Turn the seat upside down again, to pull and fasten the Velcro straps tight.
7. Check the firm fixation.
8. Reattach the seat cover by fasten the zippers and Velcro®.



Tutorial Video URL





## Securing Your Child

Once the Carrot 3 Booster Seat has been installed in the vehicle's seat and adjustments have been made, follow these instructions to secure the child.

- Loosen the harness and unfasten the harness buckles (upper and lower). Move the harness straps to the side of the seat (**Fig. A**).
- Place the child in the seat (**Fig. B**).
- Position the harness strap around the child and verify the harness is not twisted or tangled (**Fig. C**).
- Fasten the lower harness buckle first. Proper connection is confirmed with a positive click after inserting the buckle tongue (**Fig. D**).
- Gently pull the harness strap to the side to tighten the lap section (**Fig. E**).

### NOTE:

The child's hip should be positioned as deep as possible in the seat to firmly secure the child.

- Next, fasten the upper harness buckle on the chest. Proper connection is confirmed with a click after inserting the buckle tongue (**Fig. F**).
- Gently pull down the harness straps to tighten the shoulder section.



### WARNING:

In order to avoid injury or choking the child, always manually test the straps to ensure child's safety and comfort (**Fig. H**)

Reconfirm that the 4-piece harness is not twisted and the child is properly secured.



## Securing Your Child

After you secure the child with the 4-point harness, fasten the vehicle's lap shoulder 3-point safety belt over the Carrot seat routing through the RED belt guides on the child seat's shoulder (**Fig. G and H**).

Proper connection is confirmed with a click sound after inserting the buckle tongue of the vehicle's lap shoulder 3-point safety belt into the buckle of the vehicle's seat.

Verify that vehicle's lap shoulder 3-point safety belt is not twisted or sagging, and is properly routed through the RED belt guide (**Fig. I and J**).

Ensure that the vehicle's lap shoulder 3-point safety belt is positioned not to harm the face and the neck if the child.

It is required by law to use the vehicle's lap shoulder 3-point safety belt to concurrently secure a child restraint system and child.

Before every trip, make sure that the vehicle's lap shoulder 3-point safety belt is firmly fastened over the child seat, and the child is secure.

Verify that the H-shaped harness of the Booster Seat is at the position that guarantees the lap belt stays appropriately to hold the hip of the child as snugly as possible.

If you are unsure about the appropriate positioning of your child in the child restraint system, consult your dealer for immediate support.

Reconfirm that the 4-point harness is not twisted and that the child is properly secured.



FIG. G

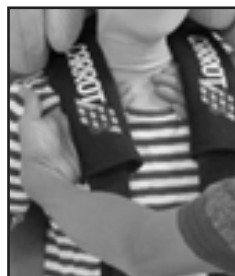

FIG. H



FIG. I



FIG. J

## Securing Your Child

- Always pull on the harness after securing the occupant to ensure the buckle tongues are secure in the harness buckle.
- Always park your car in a safe place when you make any adjustments to the child restraint system, including reclining the car seat. Adjusting and/or handling the child restraint system during driving could cause **SERIOUS INJURY** to you and your child.
- During driving, the child restraint system must be used in an upright position. Reclined position could cause the child restraint system not to perform as intended in a collision.



### **WARNING!**

It is your **RESPONSIBILITY** to use the Vehicle's Safety Belts.

**It is not sufficient to secure a child only with the 4-point harness straps of child restraint system. It is required by law to always use the vehicle's lap shoulder 3-point safety belt concurrently to secure a child seat and child.**

**Failure to use the vehicle's lap shoulder 3-point safety belt could cause your child restraint system not to perform as intended and place your child at serious risk.**

**The figure below illustrates the correct placement of the shoulder 3-point safety belt over the child restraint system.**

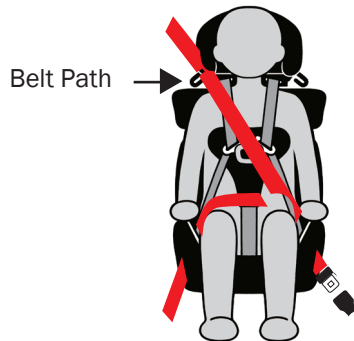

## Care and Maintenance

### **Upholstery Cover, Cushions, Pillows and Pads**

Upholstery Cover: SPONGE CLEAN using cold water & mild soap, and TOWEL DRY. Do not remove the upholstery cover. Contact the distributor for removal or replacement of the upholstery.

Cushions, Pillow, and Pads: HAND WASH using cold water and mild soap. LINE DRY or LIE FLAT to prevent shrinkage. Do not bleach, machine wash, machine dry or iron, as this may damage fabrics. When damage to fabric occurs, it must be replaced. Periodical replacement is recommended.

### **Harness Buckle**

The child restraint, the harness buckle needs to be periodically checked for performance.

If a positive click is not heard when using the harness buckle, it must be replaced.

### **Harness and Straps**

Do not take apart or attempt to take apart the harness and the straps from the child seat. If reassembled incorrectly, the child restraint may not perform as intended. Never remove the buckles and/or the buckle clasps from the harness or the straps. They cannot be reattached after removal.

## Product Dimensions

Specifications	
Overall Width	20 - 22" (510 - 560 mm)
Seat Depth	15 - 16.5" (380 - 420 mm)
Seat Width	20" (510 mm)
Extendable Backrest Height	29 - 34" (745 - 870 mm)
Product Weight	21 lbs (10.5 kg)
Target User Weight	79 - 165 lbs (36 - 75 kg)
Target User Height	57 - 70" (145 - 180 cm)



New Metal Bracket for Height Adjustment Bar



1" (25 mm)

1.5" (40 mm)

18 - 22" (460 - 560 mm)

15" (380 mm)

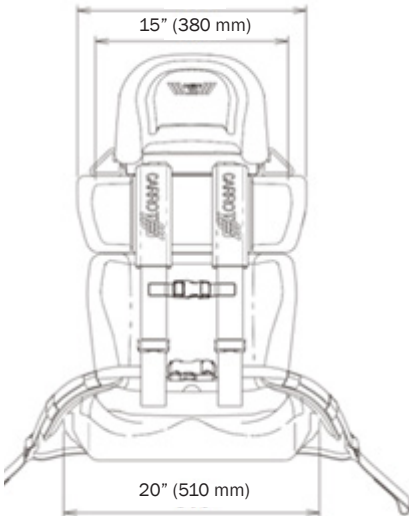

20" (510 mm)

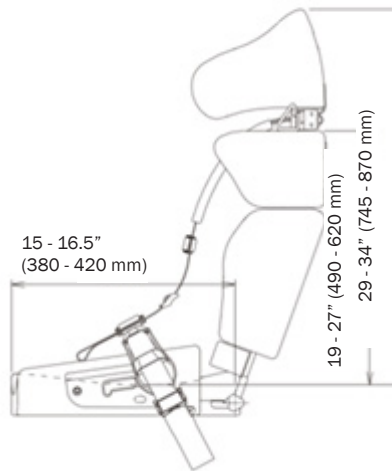

15 - 16.5"  
(380 - 420 mm)

19 - 27" (490 - 620 mm)

29 - 34" (745 - 870 mm)

## Warranty

### LIMITED WARRANTY

#### Product Model: **CARROT 3 Booster Seat**

Name: \_\_\_\_\_

Street Address: \_\_\_\_\_

City: \_\_\_\_\_ State: \_\_\_\_\_

Zip Code: \_\_\_\_\_ Country: \_\_\_\_\_

Phone Number: \_\_\_\_\_

Email Address: \_\_\_\_\_

Lot Number: \_\_\_\_\_

Serial Number: CT3 - \_\_\_\_\_

Manufactured Date: \_\_\_\_\_

Date of Purchase: \_\_\_\_\_

Dealer: \_\_\_\_\_

### **LIMITED FIVE-YEAR WARRANTY**

This product is warranted against defective materials and workmanship for five years from the date of original purchase. Proof of purchase is required.

To make a claim under this warranty, contact the authorized distributor or the retailer from whom you purchased this product. Proof of purchase is required.

### **WARRANTY LIMITATIONS**

This warranty does not include damages which arise from negligence and/or misuse not in accordance with the product instruction.

The use of other (non-Carrot 3 Booster Seat) covers, inserts, toys, accessories, or tightening devices is not approved. Their use could cause this child seat to fail Safety Standard FMVSS 213, or not perform as intended in a crash. Their use automatically voids this warranty.

### **LIMITATION OF DAMAGES**

The warranty set forth above is exclusive and in lieu of all others, oral or written, express or implied. In no event will the manufacturer, the distributors, or the retailers selling this product, be liable for any damages, including incidental or consequential damages, arising out of the use or inability to use this product.



2830 California Street, Torrance, CA 90503, USA

Toll free in the US: 1-844-US-Mobility (844-876-6245) • Phone: (310) 618-0111 • Fax: (310) 618-8811  
Email: [convaidsales.us@etac.com](mailto:convaidsales.us@etac.com) • International Email: [international.convaid.us@etac.com](mailto:international.convaid.us@etac.com)  
[www.etac.us.com](http://www.etac.us.com)

UG2100-ENG-Rev.02 2021-01-27