

Instructions for Use and Technical Description



Tom 2

Paediatric hospital bed

MET[®]
us
E212434

Complies with
UL 60601-1

D9U001K2B-0110

Version: 13

Publication Date: 2021-08

Manufacturer:

L I N E T spol. s r. o.
Želevčice 5, 274 01 Slaný
Tel.: +420 312 576 111
Fax: +420 312 522 668
E-mail: info@linet.cz
<http://www.linet.cz>

Tom 2
Pediatric hospital bed

Author: LINET, s.r.o.
Related links: www.linet.cz

D9U001K2B-0110
Version: 13
Publication date: 2021-08

Copyright © LINET, s.r.o., 2021
Translation © LINET, 2021

All rights reserved. All trademarks and brands are the property of the appropriate owners. The manufacturer reserves the right to changes in the contents of this manual that relate to the product's technical regulations. It is for this reason that the contents of this manual may indicate differences from the current manufacture of the product. Reproduction of this user manual, also excerpts, only with prior permission of the publisher. Subject to changes due to technical developments. All technical data are rated data and are subject to construction and manufacturing tolerances.

Table of Content

1 Symbols	5
1.1 Warning Notices	5
1.2 Instructions	5
1.3 Lists	5
1.4 Symbols and Labels on the Product	6
1.5 Description of label with UDI	8
1.6 Definitions	9
1.7 Abbreviations	9
2 Safety and Dangers	10
2.1 Safety instructions	11
2.2 Conditions of Use	12
2.3 Intended Use	12
3 Standards and Regulations	13
3.1 Tom 2 13	
3.2 Manufacturer	13
4 Functioning	14
4.1 Correct use	14
4.2 Incorrect Use	14
5 Scope of Delivery and Bed Variants	15
5.1 Scope of Delivery	15
5.2 Bed Variants	15
5.3 Applied parts type B	15
6 Setup	16
6.1 Transport	16
6.2 Setup	16
7 Battery Activation	17
7.1 Placement of Control Section	17
7.2 Removing the Isolating Foil	17
7.3 Isolating Foil	17
8 Putting into Service	18
8.1 Potential Equalisation	18
8.2 Mattress Platform	19
8.3 Tom 2 (1K) – Telescopic siderails with removable bed ends	20
8.4 Removable bed ends	21
9 Operation	24
9.1 Initial Operation	24
9.2 Battery	24
9.3 Status Faulty Battery	25
9.4 Status Discharged Battery	26
9.5 Removing the Bed from Service	26
10 Manipulation	27
10.1 Mini ACP (supervisor control panel)	28
10.2 Night Bed Lightning	29
10.3 CPR Back Rest Release (optionally available)	30

10.4	Auto-Regression	30
10.5	Siderails	31
10.6	Castor Control and Bed Transport.....	35
11	Patient Weighing (WS17)	36
11.1	Weighing System Control Panel.....	36
12	Accessories	41
12.1	Infusion Stand (integrated)	41
12.2	Accessory Rails	41
12.3	Protector (Roller bars)	42
13	Mattress	46
13.1	CliniCare 10P.....	46
13.2	Rotating of the mattress	46
13.3	Technical specification of the mattress.....	47
13.4	Mattress cleaning and disinfectants	48
14	Cleaning and Disinfection of the Bed	51
14.1	Safety Instructions for Cleaning and Disinfection of the Bed	51
14.2	General Instructions for Cleaning and Disinfection	52
14.3	Choosing of Detergents or Disinfections	53
15	Troubleshooting	54
16	Maintenance.....	55
16.1	Maintenance Work.....	55
16.2	Functioning	56
17	Disposal	58
17.1	Environmental Protection	58
17.2	Disposal.....	58
18	Warranty.....	59
19	Technical Specifications.....	60
19.1	Basic Specification and Bed Dimensions	60
19.2	Environmental conditions	60
19.3	Electrical Specification.....	61
19.4	Electromagnetic compatibility	61

1 Symbols

1.1 Warning Notices

1.1.1 Types of Warning Notices

Warning notices are differentiated by the type of danger using the following key words:

- ❖ **Caution** - risk of material damage.
- ❖ **Warning** - risk of physical injury.
- ❖ **Danger** - risk of fatal injury.

1.1.2 Structure of Warning Notices

 SIGNAL WORDS!
Type and source of danger!
➞ Measures to avoid the danger.

1.2 Instructions

Structure of instructions:

- ❖ Perform this step.

Result, if necessary.

1.3 Lists













Structure of bulleted lists:





- List level 1
 - List level 2

Structure of numbered lists:

- a. List level 1
- b. List level 1
 1. List level 2
 2. List level 2

1.4 Symbols and Labels on the Product

	Read user manual.
	Attention
	Thermal protection of transformer
	Only suitable for indoor use
	Protection against accidents due to electrical current – Applied part type B
	Safety isolation transformer, general
 Complies with UL 60601-1 E212434	MET Laboratories Safety Mark
	Jack for attachment of conductor for potential equalisation
 = Kg	Safe Working Load
 = Kg	Maximum weight of patient
	Use mattress recommended by manufacturer
 =135 kg	Weight of bed
	Machine wash max. 95°C (recommended 71°C for 3 minutes)

	Do not bleach
	Do not iron
	Suitable for dry cleaning
	Dry normal, low heat
	WEEE symbol (recycle as electronic waste, do not put into the household waste)

1.5 Description of label with UDI

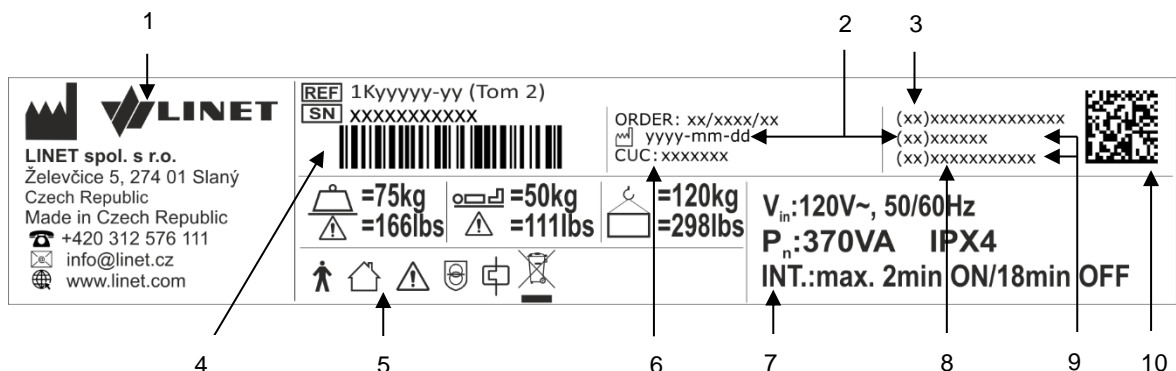

Fig. Serial Label with UDI (Tom 2 with scales)

1	Address of Manufacturer
2	Manufacturing Date (Year-Month-Day)
3	DI (Device Identifier) / GTIN (Global Trade Item Number)
4	1D Bar code GS1-128 (Serial Number)
5	Symbols
6	Configuration number
7	Electrical Specification
8	Serial Number
9	PI (Product Identifier)
10	2D Bar Code (GS1 DataMatrix) DI+PI=UDI

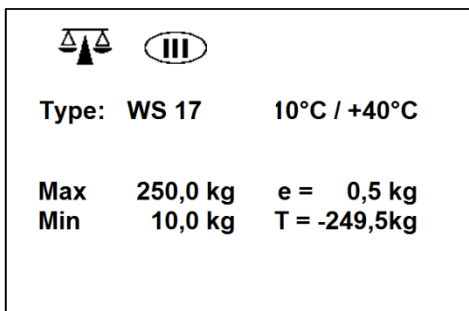

Fig. Scales label (Tom 2)

1.6 Definitions

Basic Bed Configuration	the pricelist model configuration, not including a mattress
Bed Weight	The value depends on the product configuration, accessories or customer adjustments.
Clearance of Undercarriage	the height from the floor to the lowest point of the undercarriage between the castors, for the manipulation of accessories under a braked bed in the standard position
Duty Cycle	cycle of operation of the motor: time of activity/time of rest
Maximum Patient Weight	Maximum Patient Weight depends on the application environment according to IEC 60601-2-52. For application environment 1 (intensive/critical care) and 2 (acute care) reduce Safe working Load by 65 kg. For application environment 3 (long-term care) and 5 (ambulatory care) reduce Safe working Load by 35 kg.
Safe Working Load	the highest allowable load on the bed (patient, mattress, accessories and the load supported by those accessories)
Siderail Height	the height of the upper crossbar or the edges of the siderails (not the highest point of the siderail controls) from the patient surface
Standard Bed Position	<ul style="list-style-type: none"> - The height of the patient surface with regard to the floor is 400 mm - The mattress support platform, including the individual parts, has to be in a horizontal (level - 0°) position. - The siderails are always locked in the upper position. - The basic position of the integrated extension.

1.7 Abbreviations

~	Alternating Current
CE	European Conformity
CPR	Cardiopulmonary Resuscitation
dB	Sound Intensity Unit
DC	Direct Current
EMC	Electromagnetic Compatibility
FET	Field-effect transistor
HF	High Frequency
ICU	Intensive Care Unit
INT.	Duty Cycle
IV	Intravenous
LED	Light Emitting Diodes
ME	Medical Electrical (Equipment)
MET	MET Laboratories testing and certifying for the U.S. market
OFF	Deactivated
ON	Activated
SCU	System Control Unit
SWL	Safe Working Load
UDI	Unique Device Identification (for medical devices)
USB	Universal Serial Bus

2 Safety and Dangers

 **WARNING!**

Tom 2 bed should be left in its lowest position when the patient is unattended in order to reduce risk of injury due to falls!

 **WARNING!**

Siderails of Tom 2 should be located in the „up“ position to reduce the risk of the patient accidentally slipping or rolling off the mattress!

 **WARNING!**

Incompatible siderails and mattresses can cause an entrapment hazard!

 **WARNING!**

Inappropriate handling of the power supply cord, e. g. by kinking, shearing or other mechanical damages is hazardous!

 **WARNING!**

When routing cables from other equipment in the Tom 2 bed avoid squeezing those between parts of the Tom 2 bed!

 **WARNING!**

Tom 2 bed should not be used with bed hoists and bed lifts!

 **WARNING!**

Incompatible mattresses can create hazards.

 **WARNING!**

To avoid the risk of electric shock, this equipment must only be connected to a supply mains with protective earth.

 **WARNING!**

No modification of this equipment is allowed.

 **WARNING!**

Do not modify this equipment without authorization of the manufacturer.

⚠ WARNING!

If this equipment is modified, appropriate inspection and testing must be conducted to ensure continued safe use of the equipment.

⚠ WARNING!

An additional MULTIPLE SOCKET-OUTLET or extension cord shall not be connected to the MEDICAL ELECTRICAL SYSTEM.

⚠ WARNING!

During specific investigations or treatments the significant risks of reciprocal interference posed by ME equipment may occur.

2.1 Safety instructions

- ❖ It is necessary to read the user manual before operating the bed.
- ❖ Follow the instructions carefully.
- ❖ Use the bed exclusively in its original condition.
- ❖ If necessary, check the bed functions daily or at each staff rotation.
- ❖ Use the bed exclusively with the correct mains supply.
- ❖ Ensure the bed is operated by training and qualified personnel.
- ❖ Ensure the bed is only moved or positioned upon even, hard floor surfaces listed in chapter "Transport".
- ❖ The bed is size adjusted for patients from 6 months to 4 years. Maximal height of patient is 100 cm. The bed is not designed for older or younger patients.
- ❖ Replace any damaged parts immediately with original spare parts.
- ❖ Ensure maintenance and installations are performed only by qualified personnel who have been trained by the manufacturer.
- ❖ Do not apply excess weight or load to the bed according to SWL (safe working load).
- ❖ Only one patient can use the bed at any time.
- ❖ Take care to avoid injuries or squeezing when operating moving parts.
- ❖ When using lifting poles or infusion stands, ensure nothing will be damaged when you move or adjust the bed.
- ❖ Ensure castors are braked when the bed is not being moved, regardless of whether the bed is occupied or empty.
- ❖ Ensure that siderails are operated by healthcare personnel only.
- ❖ Never use the bed in areas where there is a hazard or risk of explosion.
- ❖ Never handle the mains plug with wet hands.
- ❖ Unplug the mains cable by pulling on the plug only.
- ❖ Position the mains cable so there are no loops or bends in the cable; protect the cable from mechanical wear and tear.
- ❖ Incorrect handling of the mains cable can cause an electric shock hazard, other serious injuries or damage to the bed.
- ❖ Ensure the specified duty cycle (on-time) is not exceeded (see INT. on product label).
- ❖ Ensure moving parts of the bed are not blocked.
- ❖ To prevent failures, use exclusively the manufacturer's original accessories and mattresses.
- ❖ Adjust bed height to approx. 20 cm below maximum height when transporting the bed in order to facilitate overcoming possible obstacles.
- ❖ Ensure the bed and its components are exclusively modified with the manufacturer's approval.
- ❖ Any non-observance of this manual may lead to injuries or material damage.
- ❖ Ensure there is no risk of crushing or otherwise injuring the patient's limbs (e.g. between siderails and mattress platform, between movable parts etc.) before positioning the bed or folding down the siderails.
- ❖ Close box for linen before using the Reverse Trendelenburg.

- ❖ Do not put any objects (e.g. accessories, infusions, cables) between or on siderails and movable parts. Or between mattress platform and undercarriage of the bed.
- ❖ Ensure that nobody can get injured while folding the siderails.
- ❖ Ensure no injuries will occur when folding the siderails.
- ❖ Ensure there is no risk of damaging the MiniACP panel.
- ❖ To prevent collisions, do not put oxygen bottle holders directly under the mattress platform.
- ❖ Only use oxygen bottle holder approved by manufacturer.
- ❖ Hospital personnel are fully responsible for bed adjustments and leaving patient without supervision in accordance with evaluation of patient's health status and mental status.

2.2 Conditions of Use

The bed may not be used and stored in indoor environments:

- Where there is a risk of explosion.
- Containing inflammable anaesthetics.

The bed is designed for use in rooms for medical purposes. Electrical installations must therefore meet local standards laying down the necessary conditions for electrical installations.

- ❖ Disconnect the bed from the mains in exceptional cases (i.e. lightnings, earthquake).

2.3 Intended Use

Purpose of product:

Tom 2 is electronically positionable paediatric bed for standard and critical care. It is intended for body of patient as support during hospitalization, during mobilization and during transport of patient. Tom 2 medical bed is not intended for neonatology.

Patient:

- ❖ Tom 2 medical bed is intended for patients with maximum height of 100 cm. Weight of patient + mattress + accessories can not be higher than safe working load (SWL - 75 kg).

Personnel:

- ❖ Training and qualified medical staff (nurse, doctor) with medical school or university (EU), familiar with the manual.
- ❖ Hospital staff is responsible for assessing if the physical and psychological state of the patient is in accordance with use of Tom 2 medical bed!

Location:

- ❖ The bed is determined for hospital environment with intensive, standart and long-term care. The stable undercarriage with 4 castors makes it possible for the bed to be handled by one person. However, the manufacturer recommends that at least two persons handle the bed.

3 Standards and Regulations

3.1 Tom 2

The Tom 2 bed complies with the following standards and directives:

- IEC 60601-1
- CAN/CSA C22.2 NO. 60601-1
- ANSI/AAMI ES60601-1
- IEC 60601-1-2
- IEC 60601-1-6
- IEC 60601-2-52
- ISO 14971

3.2 Manufacturer

The manufacturer adheres to a certified quality management system in compliance with the following standards:

- ISO 9001
- ISO 14001
- ISO 13485
- MDSAP (Medical Device Single Audit Program)

4 Functioning

4.1 Correct use

DANGER!

Risk of injury or death due to use of incorrect equipment!

- ➔ Ensure the bed and its components are exclusively modified with the manufacturer's approval.

The bed is determined for hospital environment with intensive, standart and long-term care.

- ❖ Ensure the bed is operated only by trained and qualified hospital staff.
- ❖ Do not continue to use the bed which is not in pristine condition.

4.2 Incorrect Use

The bed is not suitable for adults.

- ❖ The bed is not suitable for private use.
- ❖
- ❖ Ensure the safe working load is not exceeded.

NOTE For information concerning uses other than those outlined in the "Correct Use" section above, please contact LINET®.

LINET®'s efforts in research, design and manufacture ensure LINET® products are of the highest quality and fit for their intended purpose. However, LINET® can take no responsibility for any damage to the products or any harm to patients, staff or other individuals resulting from:

- ❖ *Not following the instructions in the manual, including warning notices.*
- ❖ *Using the product for a purpose other than the intended purpose stated in the relevant documentation provided by LINET® (see Correct Use).*

5 Scope of Delivery and Bed Variants

5.1 Scope of Delivery

Delivery:

- ❖ The bed is delivered completely assembled. Upon receipt, check that the shipment is complete as specified on the delivery note. Notify the carrier and supplier of any deficiencies or damages immediately as well as in writing or make a note on the delivery note.

5.2 Bed Variants

CAUTION!

Damage to the bed due to incorrect use!

- ➞ Use 100 mm and 125 mm castors exclusively on flat, even surfaces without any gaps!

Features – Tom 2 Model 1K (model no. see product label):

- Mattress Platform
 - Two pieces mattress platform with plastic parts
- Siderails
 - Telescopic siderails
- Bed Ends
 - Removable polycarbonate bed ends
 - Removable polycarbonate bed ends with decorative motive
- Castors
 - 125 mm Tente Linea, with central braking system
- Control Elements
 - Mini ACP (supervisor control panel)
- Other
 - Box for linen (diapers/toys)
 - Pair of accessories rails
 - CPR unlocking of back rest
 - Integrated infusion stand in head end
- Powder Coating Colors
 - RAL 9002 (white) with pastel blue plastic parts
 - RAL 9002 (white) with pastel green plastic parts

5.3 Applied parts type B

All the accessories the patient can reach are type B applied parts.

List of type B applied parts:

- ❖ Siderails
- ❖ Bed ends
- ❖ Mattress platform

6 Setup

6.1 Transport

For safe transport, observe the following:

- ❖ Ensure no cables are run over when moving a bed.
- ❖ Ensure the mains cable is disconnect from the mains.
- ❖ Ensure the mains cable is attached with a hook (at the head end of the bed).
- ❖ Ensure the castors are unlocked before moving the bed during the loading/unloading process (see Castor Control and Bed Transport).
- ❖ Ensure the siderails are lifted and locked while the patient is on the bed during the transport.
- ❖ Move the bed only on suitable floor surfaces.

Suitable surfaces:

- Tile
- Hard linoleum
- Hard flooring

Unsuitable surfaces:

- Soft, unsealed or defective flooring
- Soft wooden flooring
- Soft and porous stone floors
- Carpeted floors with underlay
- Soft linoleum
- ❖ For longer distances, ensure the castor steering function (main control) is activated.
- ❖ Ensure the brakes are released while moving the bed.

6.2 Setup

Set up the bed as follows:

- ❖ Unpack the bed.
- ❖ Remove isolating foil from mains control box (see Battery Activation).
- ❖ Check the delivery (see Scope of Delivery).
- ❖ Install equipment and accessories (see Assembly).
- ❖ Set up the bed exclusively on a suitable floor surface (see Transport).
- ❖ Ensure the mains cable does not collide or get stretched when adjusting the bed. Check the plug is inserted correctly.
- ❖ Do not leave any extension cords or power strips loose on the floor.
- ❖ Ensure all the required mechanical and electrical prevention mechanisms are available on site.
- ❖ There is no mains switch on the bed, i.e. the mains cable is the only means to isolate the bed from the mains.
- ❖ Ensure the mains cable is always accessible.
- ❖ The plug on the mains cable should only be changed and maintained by qualified and trained service technicians authorised by the manufacturer.

6.2.1 Connection to the mains

Where the integrity of the external protective conductor in the installation or its arrangement is in doubt

- ❖ operate the bed from internal battery only.

NOTE: Attachment plug is means of disconnecting bed from the mains.

7 Battery Activation

7.1 Placement of Control Section

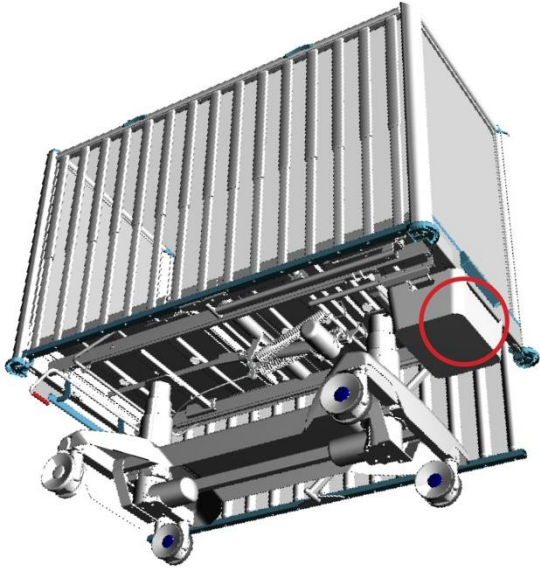

7.2 Removing the Isolating Foil

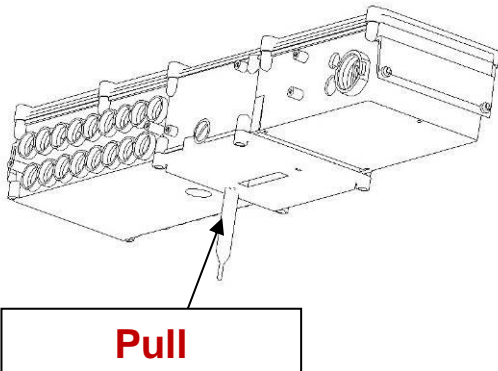

7.3 Isolating Foil

Check if isolating foil is complete and undamaged as shown:

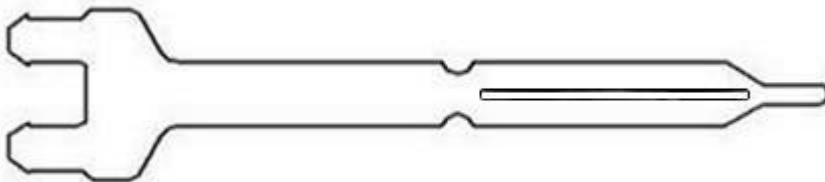

If isolating foil is damaged, contact the manufacturer's service department immediately.

NOTE: It is recommended to wear gloves when removing the isolating foil.

8 Putting into Service

WARNING!

Risk of injury when working on the bed!

- Ensure the bed is disconnected from the mains connection prior to putting into service and maintenance.
- Ensure the castors are locked prior to putting into service and maintenance.

CAUTION!

Material damage due to incorrect putting into service!

- Ensure the putting into service is performed only by customer service or trained hospital personnel.

8.1 Potential Equalisation

The bed is equipped with a standard protective connector. This connector is used for potential equalisation between the bed and any intravascular or intracardiac device connected to the patient to protect the patient from static electric shocks.



Fig. Potential equalisation connector – male



Fig. Potential equalisation connector – female

Use equalisation connector if:

- The patient is connected to any intravascular or intracardiac device.

Before connecting the patient to an intravascular/intracardiac device:

- ❖ Connect the ground wire of the device to the potential equalisation connector on the bed on which the patient in question is lying.
- ❖ Use a standard hospital connector.
- ❖ Make sure the connectors match.
- ❖ Make sure there is no possibility of accidental disconnection.

Before moving the bed:

- ❖ Disconnect the patient from the intravascular or intracardiac device.
- ❖ Disconnect the potential equalisation connector.

8.2 Mattress Platform

The mattress platform consists of plastic sections.

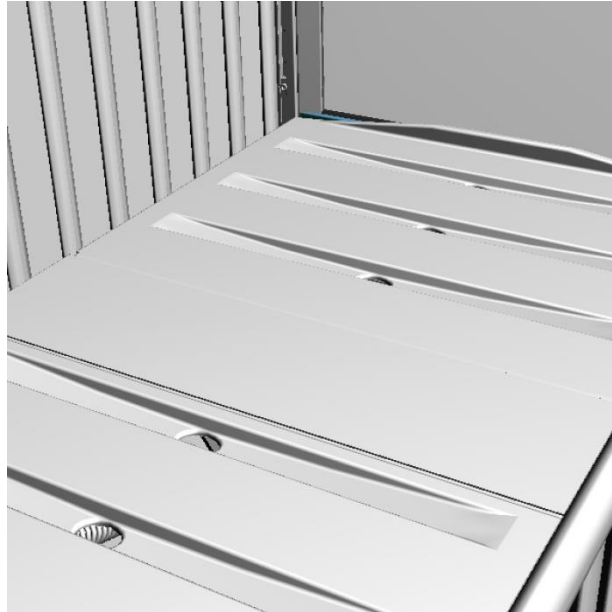

Correct placement of the patient on the bed:

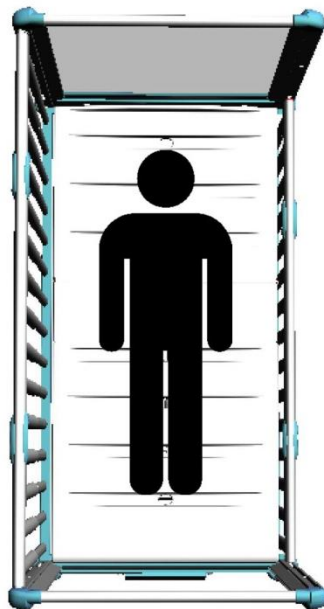

Fig. The patient orientation on the bed (Mini ACP is located at the foot of the patient).

8.3 Tom 2 (1K) – Telescopic siderails with removable bed ends

CAUTION!

Material damage due to excess load!

- ➔ Ensure nobody burdens siderails or bed ends.

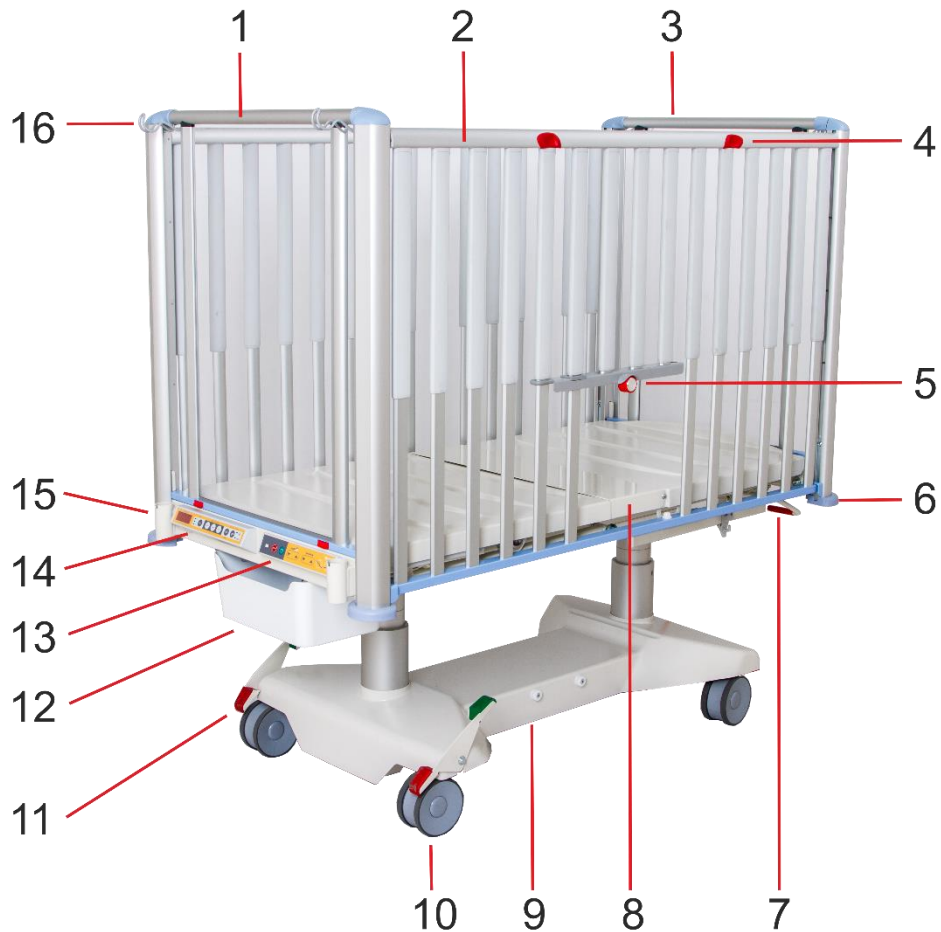

Fig. Bed Overview

1. Removable foot end
2. Telescopic sid rail in upper position
3. Removable head end
4. Siderail release mechanism
5. Openable siderail bar (locking pin)
6. Protective bumper 100 mm
7. CPR control lever – backrest release
8. Mattress platform
9. Undercarriage cover
10. Castor 125 mm (Tente Linea)
11. Castor control lever
12. Box for linen (diapers/toys)
13. Mini ACP (supervisor control panel)
14. Scales control panel
15. Holder for extension system or accessories
16. Hooks for removable bed end

8.4 Removable bed ends

WARNING!

Risk of injury due to wrongly installed bed ends!

- After each installation of bed ends always check if the bed ends are properly locked.
- Always check if the sheet does not obstruct the bed end locks.
- The safe position for patient who is left without supervision of personnel is with installed bed ends and with siderails in highest position. In all other cases (e.g. siderails down, removed bed ends etc.) the patient must be under supervision of personnel.
- Avoid injuring patient while removing bed ends or remove bed ends only on the bed without patient.
- Ensure the accessories / extension placed in holder will not collide with bed end when removing it. Otherwise remove accessory / extension.

The bed Tom 2 can be equipped with removable bed ends on the customer's request. Removable bed ends allows easier access to the patient.

To remove bed ends:

- ❖ Unlock both locks on the bottom part of the bed ends by pushing in the direction of arrows (1).
- ❖ Grab the bed ends with both hands in the upper half of the bed end (2).
- ❖ Lift the bed end up (2).
- ❖ Rotate the bed end slightly into the bed (3).
- ❖ Remove the bed end.



Fig. Removing the bed ends

To place bed ends on the bed:

- ❖ Insert the bed end into the bed (1).
- ❖ Put the bed end into the guides on top and bottom of the columns (2 & 3) on both sides.
- ❖ Slide the bed ends down until it clicks into its place (4) (audible “click” will be heard).
- ❖ Check the bed end is locked in its place and that the upper corners bear on the bed end columns.

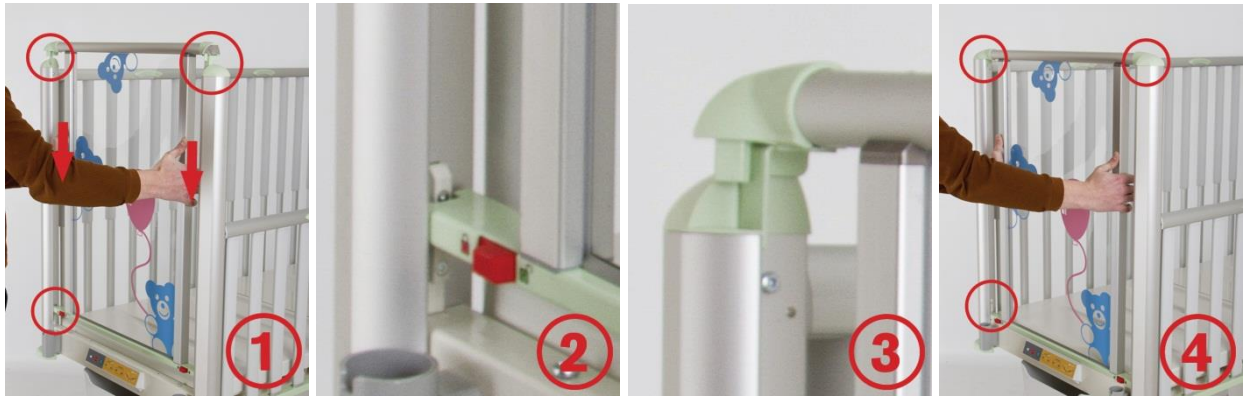



Fig. Placement of the bed ends

8.4.1 Removable foot end and head end with hooks

Removable foot end and removable head end is equipped with hooks. The hooks are intended for hanging of removable head end or foot end when removed.

 WARNING!
Risk of injury due to wrongly located foot end or head end!
➡ Do not hang removable foot end or head end on any siderail!

 CAUTION!
Material damage due to incorrect manipulation with hooks!
➡ Do not hold the hooks during manipulation with removable foot end or head end!

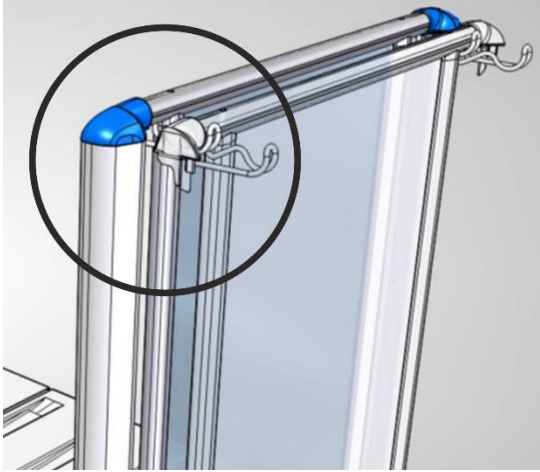
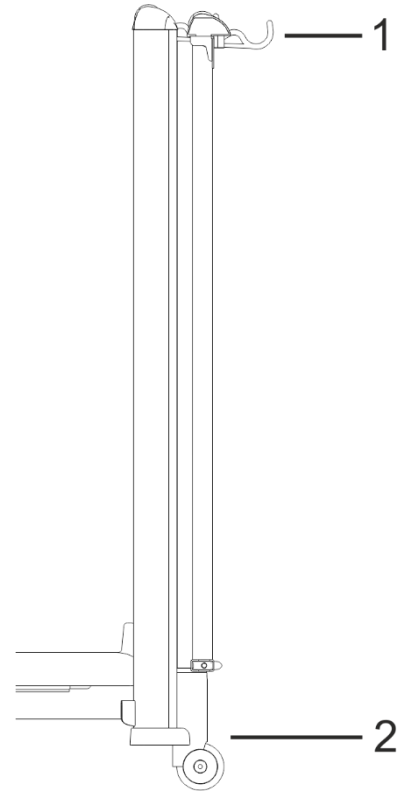

Fig. Correct placement of head end in the hooks

- 1 Hook
- 2. Accessory holder with bumpers



9 Operation

9.1 Initial Operation

CAUTION!

Material damage due to temperature difference!

- If there is a considerable temperature difference between the bed and the place of operation (after transport/storage), leave bed unconnected for 24 hours to allow the temperature to equalise.

Prepare the bed for service as follows:

- ❖ Connect the bed to the mains.
- ❖ Raise the mattress platform to the highest position.
- ❖ Remove the isolating foil from control section.
- ❖ Lower and tilt the mattress platform to the lowest position.
- ❖ Check the castors and main brake work correctly.
- ❖ Check all of the functions on the control elements (Mini ACP control panel).
- ❖ Check the siderails function properly.
- ❖ Dispose of all packaging (see Disposal).

9.2 Battery

For declared lifetime period of leaded accumulators is recommended during storage:

1. To prevent accumulators from deep discharging (state-of-charge under 10%) and to keep accumulators at least partly charged by regular recharging
2. To store accumulators on dry and cold places (from 10°C to 0°C)
3. To prevent accumulators from being in the sunshine

CAUTION!

Risk of reducing battery durability due to incorrect use!

- Use bed on battery only in crisis situations (e.g.: power blackout, patient complications during transport, etc.).
- After reconnecting bed to the mains charge battery to full capacity (see chart Battery charge status).

CAUTION!

Risk of damage or destruction of battery!

- If the battery is faulty, degassing may occur. In rare cases this might cause deformations of the battery case, control panel housing or cable.
- If this occurs stop using the bed immediately (see Removing the Bed from Service).
- Inform the manufacturer's service department immediately.

The battery supplied with the bed is delivered uncharged. The battery serves as a backup during power failures or while transporting the patient.

- ❖ Use only batteries approved by the manufacturer.
- ❖ The manufacturer provides a 6-month warranty for the full function of batteries.

- ❖ Check the battery functionality at least once a month in accordance with the user manual and have the battery changed if necessary.
- ❖ The manufacturer recommends to replace the battery by qualified service organization after 2 (two) years of use. After this period the supposed service life of battery ends and the manufacturer cannot guarantee the battery service life after this period.
- ❖ The battery must be replaced with the new battery approved by manufacturer after maximum 5 (five) years of use at the latest.
- ❖ The manufacturer will assume no responsibility for any damage to the bed or the battery caused by:
 - Non-observance of the manufacturer's instructions in the user manual.
 - Using batteries not approved by the manufacturer.
 - Battery replacement non-qualified service organisation.

To charge the battery:

- ❖ Connect the bed to the mains and check the yellow LED on the Supervisor control panel according to the table 1.
- ❖ Charging and battery capacity is indicated by the yellow LED placed on the Mini ACP control panel.

The LED indicates the battery's charge status:

Yellow LED	Battery charge status
Not lit	Battery capacity is sufficient (charging completed)
Short flashing (short, intermittent illumination) (circa 1.8 sec.)	Battery is charging - continue charging until the LED is extinguished. In emergency cases, the battery can be used as a backup power source for a short period. If LED is still flashing after 12 hours of charging or stops flashing, but you can not position with bed, battery is defective or broken. Contact manufacturer.
Long flashing (long illumination) (circa 0.2 sec.)	Low battery voltage - battery can not be used as a backup power supply even for a short period; battery is completely discharged or defective (if this type of signalisation persists, it is necessary to replace the battery - service action)
Long, intermittent illumination for several hours (circa 10 hours), when bed is connected to the mains.	Battery absence or failure condition (battery is connected incorrectly, line between the power supply and battery is broken or battery fuses are faulty); contact service department of the manufacturer in case of such signalisation.

Table 1 MiniACP control panel – battery signalization

To maintain maximum functionality of the battery:

- ❖ Unplug the bed from the mains as least as possible.

In case the battery cover or control section is deformed by heat

- ❖ Unplug the bed from the mains.
- ❖ Do not use the bed (see. Removing the Bed from Service).
- ❖ Contact service of the manufacturer.

9.3 Status Faulty Battery

The battery is regarded as faulty if at least one of the following conditions applies:

- ❖ Battery charging constantly
- ❖ Low voltage on battery
- ❖ Low charging current of battery

Status “faulty battery” is indicated:

- ❖ By the battery status indicator being constantly lit.
- ❖ A fault battery status can be cancelled by pressing the STOP button.
- ❖ Battery status data is saved to the Linis system and written to the “Blackbox”.

9.4 Status Discharged Battery

The battery is regarded as discharged if the following condition is met:

- ❖ Defined decrease of voltage depending on discharging current

Status “discharged battery” is:

- ❖ Status is indicated by the battery status indicator flashing quickly.
- ❖ This status will be cancelled automatically when the bed switches to sleep mode.

9.5 Removing the Bed from Service

How to remove the bed from service:

- ❖ Disconnect the bed from the mains.
- ❖ Disconnect the ground wire.
- ❖ Remove accessories.

To prevent damage during storage:

- ❖ Pack or cover the bed and accessories.
- ❖ Ensure storage conditions are the same as the operating conditions.

NOTE: *The bed can be removed from service only by a qualified service organization.*

10 Manipulation

WARNING!

Risk of injury when adjusting the bed!

- Ensure there are no body parts between the mattress platform elements and the mattress platform frame when adjusting the bed.
- Ensure there are no body parts below the mattress platform frame before adjusting the bed.
- Secure or remove any items on the bed.

WARNING!

Risk of injury due to moving parts!

- Ensure no body parts are trapped between moving parts of the bed with accessories and mattress platform.

CAUTION!

Material damage due to moving parts!

- Ensure no objects (e.g. cables) are trapped between moving parts of the bed and mattress platform.
- Ensure no objects are close to the bed or accessories (e.g. infusion stand, lifting pole) when the mattress platform is moving.

Control elements:

- ❖ Mini ACP (supervisor control panel)

10.1 Mini ACP (supervisor control panel)

Mini ACP is main control panel of the bed. The Mini ACP control panel is placed on the frame of the bed under the foot end.

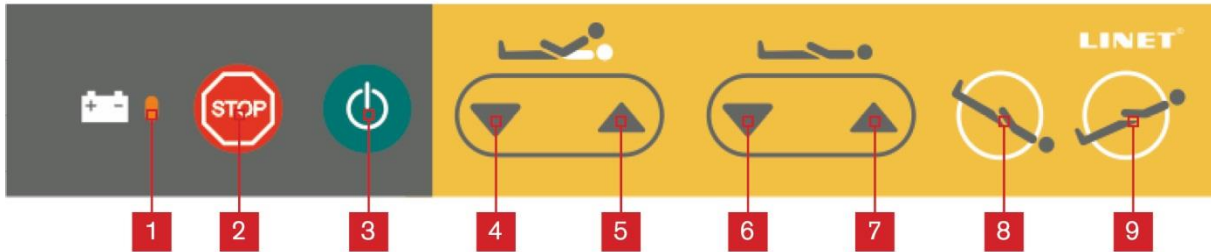

Fig. Mini ACP (supervisor control panel)

- 17. LED Battery charge status
- 18. Central "STOP" Button
- 19. Central "GO" Button
- 20. Backrest Positioning Button – down
- 21. Backrest Positioning Button – up
- 22. Height Adjustment Button – down
- 23. Height Adjustment Button – up
- 24. Button Trendelenburg (mattress platform tilt only)
- 25. Button Anti Trendelenburg (mattress platform tilt only)

To set positions:

- ❖ Activate the keypad by pressing the GO button.
- ❖ Press and hold corresponding button until required position is reached.

10.1.1 Central STOP Button

The central STOP button **2** immediately interrupts all bed movements.
Pressing central STOP button **2** for at least 0.3 seconds immediately stops all electronic bed movements.

NOTE: The bed can be stopped by pressing two different buttons even on two different controllers. If the press of the buttons is longer than 0,5 second the bed will stop all the movements immediately.

10.1.2 Activating GO Button

The GO button **3** activates the keypads on all control elements.

10.1.2.1 GO period

After pressing GO button **3**, the keypad will remain active for 3 minutes. It is possible to control every function on the bed.

Pressing a function button will keep the keypad active for another 3 minutes.

It is necessary to activate the keypad again if the 3 minute period without pressing any function is passed.

NOTE It is possible to move or position the bed continuously during 2 minutes from 20 minutes.

10.1.3 Position Buttons

It is possible to adjust all the positions thru Mini ACP control panel. The Mini ACP can adjust height of the mattress platform and the tilt angle of the back rest or mattress platform. The positions can be set by pressing function buttons **4, 5, 6, 7, 8** and **9**.

To set the positions:

- ❖ Activate the keypad by pressing the GO button.
- ❖ Press and hold corresponding function button until the desired position is reached.

10.2 Night Bed Lightning

Tom 2 is equipped with undercarriage lightning. The lightning helps the patient or hospital personnel to better orientate in room with lowered or turned off light. The lowered intensity of lightning is set up after turning the bed on. For additional informations about bed lightning see the following chapter.

10.2.1 Bed illumination

The bed is equipped with three-phase illumination:

1. Lowered intensity of illumination
2. Full intensity of illumination
3. Illumination is turned off

The lowered intensity of illumination is set up after the bed is turned on.

After pressing the GO button:

- ❖ The bed illumination will light up at full intensity for 10 minutes.

After 10 minutes the bed illumination will be lowered.

When the bed is disconnected from the mains illumination lights up for 3 minutes after pressing the GO button.

In the case any button is pressed:

- ❖ For few seconds the bed illumination will light up at full intensity.

When the bed is disconnected from the mains illumination lights up for few seconds after pressing any button.

Turning off bed illumination:

- ❖ Disconnect bed from the mains.

After disconnection of the bed from the mains illumination lights up for few seconds.

10.3 CPR Back Rest Release (optionally available)

⚠ WARNING!

Risk of injury due to lowering the backrest too quickly!

- Ensure the telescopic siderails are in their lowest position!
- Ensure there are no body parts between siderails and backrest.

The bed permits mechanical lowering of the backrest for emergency resuscitation (CPR) procedures. There are two CPR control levers located under the bed frame under the head end for this purpose.

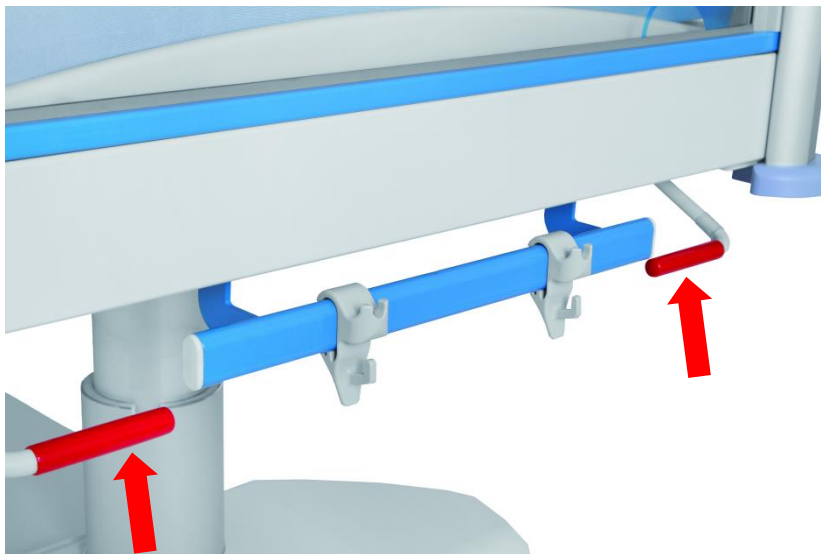

Fig. CPR Backrest release

Set the position as follows:

- Grab and hold one of the CPR control levers.
- Press the backrest down.

10.4 Auto-Regression

To eliminate pressure on the pelvis of the patient as it is raised, the backrest moves in the opposite direction when the bed is adjusted.

Benefits of auto-regression:

- Prevents decubitus.
- Increases the sitting area by 11 cm in the maximum upright position.

NOTE Only mattress with manufacturer's approval is in accordance with these benefits.

10.5 Siderails

The telescopic siderails are components of the bed. The siderails cannot be dismantled. The hospital personnel is responsible that siderails are locked in the highest position when the patient is on the bed.

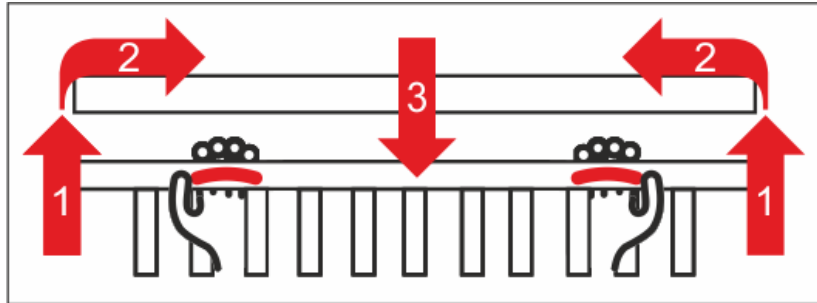

Fig. Fold siderail down

To fold siderail down:

- ❖ Grab the siderail by its locking handles and lift it to the highest position 1.
- ❖ Press and hold both locking handles against each other 2.
- ❖ Fold the siderails down to its lower or lowest position.

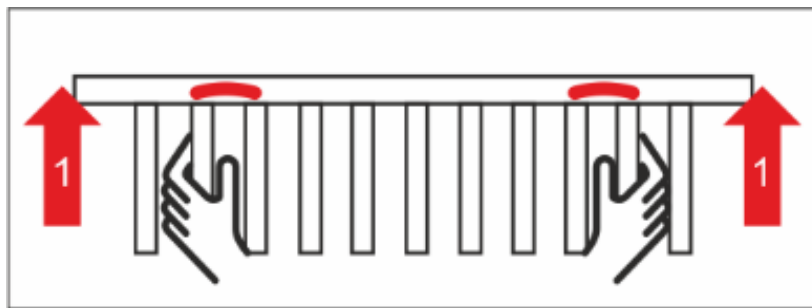

Fig. Fold siderail up

To fold siderail up:

- ❖ Grab the siderail by vertical bars and lift it to its higher or highest position 1.
WARNING!: Do not grab the siderails by the locking handles when lifting them up!
- ❖ The locking mechanism of siderail is indicated by an audible „click“ when locked in place.
WARNING!: Please ensure you reach the selected height when lifting the siderails up.
- ❖ Ensure the siderails are locked by pulling it up, down and sideways.
WARNING!: When you lift the siderail with one hand please ensure the siderail will be locked on its left and right side.



Fig. Incorrectly locked siderail

10.5.1 Openable siderail bars (optionally)

WARNING!

Risk of damaging due to incorrect use!

- Always ensure the openable bar is locked properly. Check the locking by pulling the bar up, down, towards and from you.
- Never leave the bed with opened bars without supervision of hospital personell if the patient is on the bed.
- Ensure that no accessories is blocked in locking mechanism or is blocking the locking mechanism.
- Do not position siderail if openable siderail bar is not locked in the lowest position!
- Openable siderail bars are equipped with safety brake reducing speed of their uncontrolled lowering. The brake is effective when time of uncontrolled lowering to the down position is more than 1 second.

It is possible to equip the bed with openable siderail bars. This allows using e.g. radon bottles without having to fold whole siderail down.

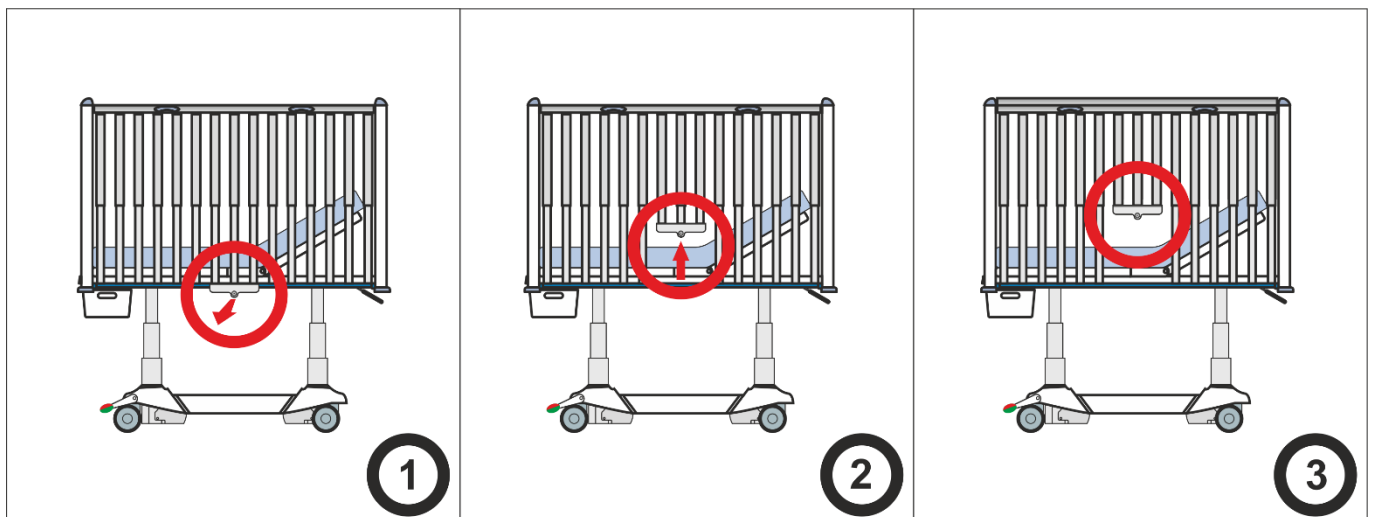

Fig. Opening the siderail bars

Open the siderail bar as follows:

- ❖ Pull and hold the locking pin towards you (1).
- ❖ While still holding the locking pin, lift the bar up to the highest position (2).

Magnet holds siderail bars in the highest position.

Siderail bar has been opened (3).

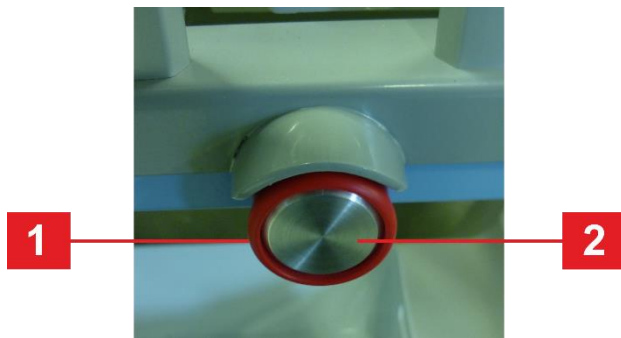

Fig. Locking pin

- 1 Red bushing
- 2 Center of button

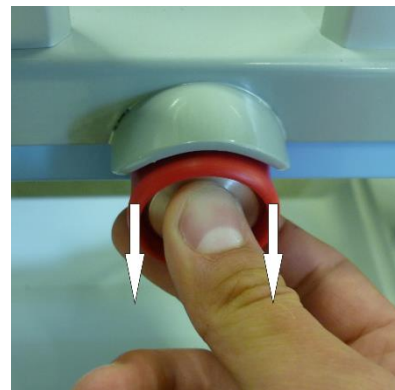

Fig. Pull red bushing towards you

Close the siderail bar as follows:

- ❖ Push the siderail bar down carefully until it latches into locked position.
- ❖ Ensure the locking pin is secured in the bushing properly.

⚠ CAUTION!

Material damage due to incorrect using!

- ➡ Avoid obstacles during closing siderail bars.
- ➡ Ensure siderail bars are carefully locked in lowest position.

10.5.2 Positions of siderails

It is possible to fix siderails in 5 positions.

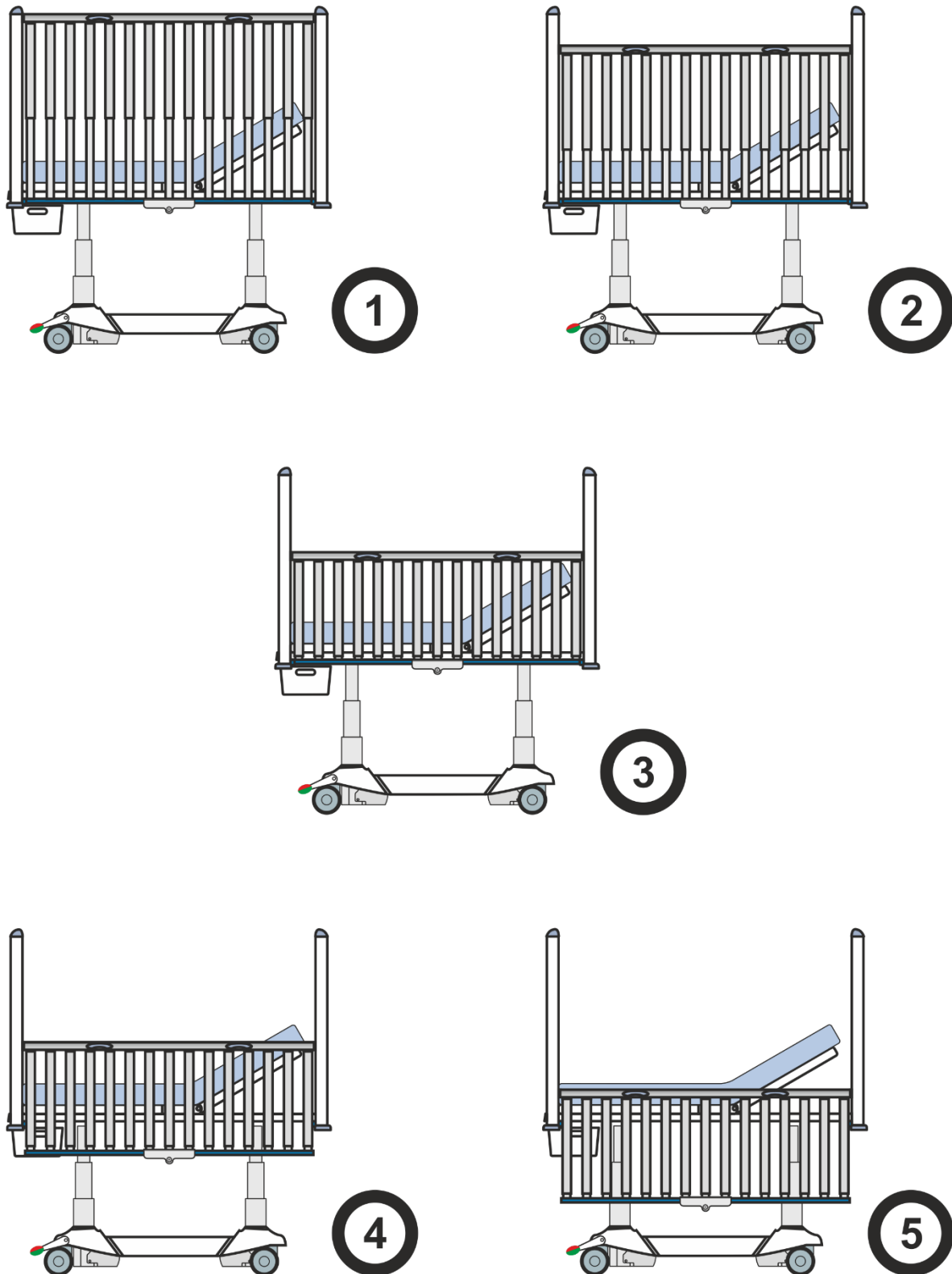

Fig. Positions of siderails

10.6 Castor Control and Bed Transport

CAUTION!

Material damage due to incorrect transport or involuntary movement!

- Prior to assembly, disassembly and maintenance, ensure the castors are locked.
- Ensure the castors are locked while the bed is occupied and/or not being transported.
- Prior to transport, ensure that bed is disconnected from mains.
- Put mains cable on hook provided for transport.
- Have the bed transported only by nursing or trained personnel.

Castor control:

The castor control levers are placed on the foot end of the undercarriage.

Castor Control Levers:

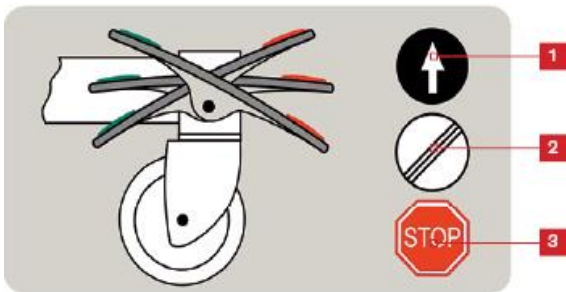

Fig. Central braking system lever

1. Forward Movement

The front left castor is locked. The bed moves straight ahead.

2. Unrestricted Movement

All of the castors are unlocked.

3. Braked

All of the castors are locked.

To move the bed:

- ❖ Adjust the bed height to at least 20cm below maximum height.
- ❖ Push the bed using columns on head or foot end.

11 Patient Weighing (WS17)

11.1 Weighing System Control Panel

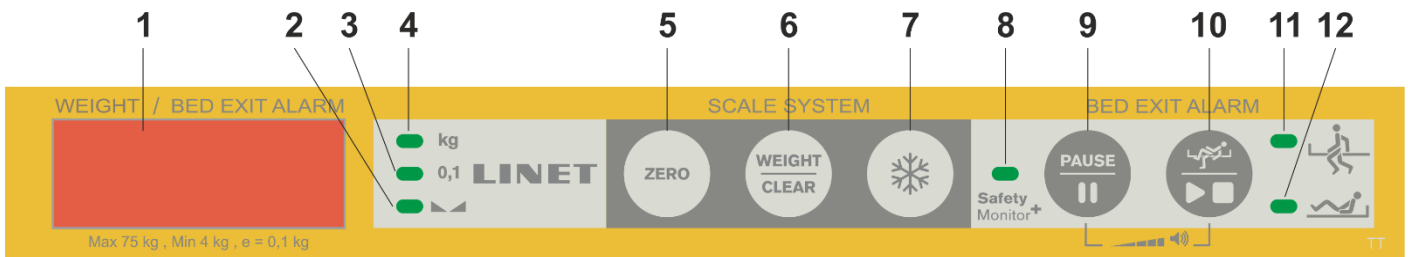

Fig. Weighing System Control Panel

1. Display - weight value
2. Indicator of Stabilized Scales
3. Indicator of value with scale interval 0,1kg
4. Indicator of unit of weight (kg)
5. ZERO button – zeroing or taring
6. WEIGHT/CLEAR button - cancelling
7. HOLD button
8. Indicator of SafetyMonitor (ON/OFF)
9. PAUSE button
10. BED EXIT ALARM button
11. Indicator of Bed Exit Alarm Outer Zone
12. Indicator of Bed Exit Alarm Inner Zone

1) Preparation

- ❖ Install mattress and accessories to prepare bed before patient admission and using the scales.



CAUTION

Incorrect use of scales due to incomplete preparation!

- ❖ Before each patient admission tare the scales.

2) Taring

The taring is done in the range from 1,5kg to 74,9kg. The taring is used to set “0” on the display before placing the patient on the bed. It is used to show actual weight of the patient.

The taring must be done on the unloaded bed without patient. It is recommended to position mattress platform in the horizontal position about 20 cm above the lowest position.

To tare weight:

- ❖ Ensure that nothing touches the bed except you.
- ❖ Press icon 5 (ZERO) for 0,5 s until the display starts to flash.
- ❖ Press icon 5 to confirm taring. The „0“ is shown on the display.

Place the patient on the bed.

To cancel taring:

- ❖ Press icon **6** while taring.

3) Displaying

Display **1** shows normally actual weight. Indicator of unit of weight **4** and indicator of stabilized scales **2** are lit at the same time when the weight value is displayed.

Weight indicator is accurate to ± 0.2 kg. Actual scale interval is 0,1 kg. Lit indicator **3** indicates the actual scale interval 0,1 kg.

Display **1** is not used for scales signalization if indicators **2**, **3** and **4** are turned off.

Hidden weight value

Indicated weight value will automatically disappear after 1 minute if the corresponding configuration allows that. In this configuration it is possible to display the weight value again by pressing any button in the section SCALE SYSTEM (buttons **5**, **6** or **7**).

4) Hold Mode



Hold Mode must be used only when the scales are stabilized.

It allows adding or removing bed accessories and other items without changing the weight value on the display.

To activate Hold Mode:

- ❖ Wait 5 s until the scales are stabilized. The indicator **2** will be illuminated when the scales are stabilized.
- ❖ Press button **7** for 2 s.
- ❖ The display shows „**Hold**“.
- ❖ Add or remove required accessories.

To deactivate Hold Mode:

- ❖ After adding or removing accessories wait 5 s, until the scales are stabilized on the display. The indicator **2** will be illuminated when the scales are stabilized.
- ❖ Press button **7** for 2 s.
- ❖ The display shows the original weight value.

To deactivate Hold Mode without fixing the weight value:

- ❖ Press button **6**.

5) Setting Mode

To set date, date format and time:

- ❖ Press button **5** and button **7** simultaneously for 3 s.

The value to be changed flashes on the display.

To navigate in list:

- ❖ Press button **5** or button **7** to go up or down in the following list:

1. minutes
2. hours
3. date format (month-day/day-month)
4. year
5. month
6. day

To leave setting mode:

- ❖ Press button **6**.

Setting Mode is left without saving the last setting.

6) BED EXIT ALARM

BED EXIT ALARM is function monitoring patient's presence on selected zone of the bed.

A noticeable weight drop will activate the acoustic alarm. During this alarm "BEA" and "ALA" alternate on the display 2 times each second. Indicator of selected zone (**11** or **12**) is lit at the same time.



To deactivate BED EXIT ALARM:

- Press BED EXIT ALARM button **10** for 2 s.

"BEA" and "OFF" alternate on the display 2 times each second.





To activate BED EXIT ALARM:

- Press BED EXIT ALARM button **10** for 2 s.

Inner Zone is indicated by indicator **12**.

To switch between BED EXIT ALARM zones:

- Press BED EXIT ALARM button **10** shortly to change zone of the BED EXIT ALARM.

Inner Zone (indicator 12)

- ❖ Alarm starts when patient moves from the limited area.

Outer Zone (indicator 11)

- ❖ Alarm starts when patient leaves bed.

NOTE Inner zone Monitoring is the default mode when the Bed Exit Alarm is activated.

To set up the alarm volume:

- ❖ Press button **9** and button **10** simultaneously until the desired volume is reached.

NOTE: If the alarm is set to minimum volume the alarm is mute.

To pause BED EXIT ALARM:

- Press PAUSE button **9** for 2 s.

“**P 15**” is shown on the display. It indicates PAUSE period for 15 minutes.

Decreasing number next to “**P**” indicates countdown.

During PAUSE period no acoustic alarm is activated.



7) Bed Overload

If the bed load is over 75,9kg:

- ❖ Overloading is signaled by long acoustic signal.
- ❖ The „**Hi**“ icon is displayed on the display.

NOTE: If the bed is overloaded then it is impossible to position or manipulate with the bed until the overloading is removed.

NOTE: The bed overloading has always higher priority than Hold Mode and Taring function.

8) Bed Underload

In case the bed is underloaded (factory zero – 1,5kg):

- ❖ The display shows icon „LO“.

9) Zeroing Scales

The zeroing can be done only in the range $\pm 1,5\text{kg}$ from the factory zero. The zeroing is used to reset weight value on the display and also to set up user zero, which sets the maximum weight range of the weighting system.

The zeroing must be done on the empty, unloaded bed without mattress and accessories. The zeroing is done after installation, weight verification or servicing.

To zero scales:

- ❖ Remove all accessories and mattress from the bed. Position the bed about 20 cm above the lowest position and the mattress platform to the horizontal position. Ensure that nothing touches the bed except you.
- ❖ Press button **5** (ZERO) for 0,5s until weight value starts to flash.
- ❖ Press button **5** to confirm zeroing.

„0“ is shown at the display and acoustic signal confirms zeroing.

To cancel zeroing:

- ❖ Press button **6** while zeroing.

12 Accessories

! WARNING!

Risk of injury due to incompatible accessories!

- ➔ Only the manufacturer's original accessories can be used.

NOTE: The manufacturer assumes no responsibility for the use of accessories not approved by the manufacturer.

List of available accessories:

- IV holder (integrated)
 - chrome-plated with 4 plastic hooks
- Infusion bottle basket
 - For IV pole, stainless steel
- Oxygen bottle holder
- Pole for devices and accessories
 - chrome-plated

NOTE: It is possible to attach additional IV pole compatible with Tom 2 to the bed.

12.1 Infusion Stand (integrated)

! WARNING!

Risk of injury due to using of unsuitable accessories!

- ➔ Use infusion stands exclusively for accessories listed in the instructions for use.
- ➔ Do not use infusion stands for hanging infusion pumps, dosing devices etc. as this equipment might collide with movable parts of the bed.
- ➔ Never use infusion stand to manipulate the bed.
- ➔ In case of not following instructions from user manual there is a risk of collision with movable parts of the bed or injuring patient.

Infusion stand is integrated in the corner of head end.

- ❖ Use exclusively infusion stands with 4 hooks for hanging IV bags or baskets for intravenous solutions.
- ❖ Ensure that the weight-bearing capacity of the 4 hooks is not exceeded.
Capacity per hook: 5 kg

12.2 Accessory Rails



Load capacity:

- ❖ Maximum load of 5 kg without leverage.
- ❖ Maximum load of hook pair 10 kg.

Accessories for hanging on the accessory rail:

- ❖ Cannula holder
- ❖ Urine bag holder
- ❖ Urine bottle basket
- ❖ DIN steel bar

Fig. Accessory Rail

12.3 Protector (Roller bars)

WARNING!

Risk of injury for patient or hospital staff due to incorrect installation of protector:

- Only people who are familiar with this user manual are allowed to perform installation of protector, removal of protector or other manipulation with installed protector! Manufacturer is not responsible for possible injuries of patient or other persons caused by non-observance of the instructions in this user manual!
- It is not allowed to perform installation of protector, removal of protector or other manipulation with installed protector when there is a patient on the bed!
- After installation or removal, ensure that each safety screw is tightened with torque 5+2 Nm!
- Before use the protector must be installed on the bed correctly according to this user manual!
- Protector is not compatible with Infusion stand installed in the corner of the Tom 2 bed!

WARNING!

Risk of injury for patient or hospital staff due to incorrect use of protector:

- Hospital staff is responsible for assessing if the physical and psychological state of the patient is in accordance with use of the protector!
- Hospital staff is responsible for assessing if the patient may be left unattended on the bed with installed protector!
- Hospital staff is responsible for assessing whether bedclothes, toys or other objects of larger dimensions increase the risk of patient's climbing over the siderails or bed ends!
- Use of protector is not allowed in emergency cases or crisis situations where the patient or hospital staff could be injured!
- **USE OF PROTECTOR IS NOT ALLOWED IF SIDERAILS ARE NOT UPRIGHT IN THE HIGHEST POSITION!**
- Use of protector is not allowed if bed ends are not correctly locked or are removed from the bed!
- During use of the protector, it is not allowed to adjust backrest and mattress platform should be in the horizontal position!

Intended use: The protector is intended for reduction of probability that the patient will leave the bed. Protector is not 100% protection against patient leaving the bed.

Mechanism of effect: The protector raises the height of both the siderails and the bed ends based on its location. The shape and rotating motion of the protector make it more difficult for the patient to grasp the edges of the bed and climb out.

Location: The protector is installed around the perimeter of the bed (above siderails and bed ends). It is firmly fixed on each of the 4 upper corners of the bed.

Instructions for installation:

It is recommended that 2 people install the protector.

- 1) Connect all 4 protector rollers so that pins of shorter rollers are inserted into the bushings of longer rollers (position **1** on both pictures below).
- 2) Insert pins of the assembled protector into bushings on upper corners of the bed (position **2** on both pictures below).
- 3) Fix the protector with safety screws on the 4 upper corners of the bed (position **3** on second picture below).

- 4) After each installation ensure that safety screws on the 4 upper corners of the bed are tightened and the protector is firmly fixed with them. Use an allen key (size 5 mm) to tighten screws with torque 5+2 Nm.

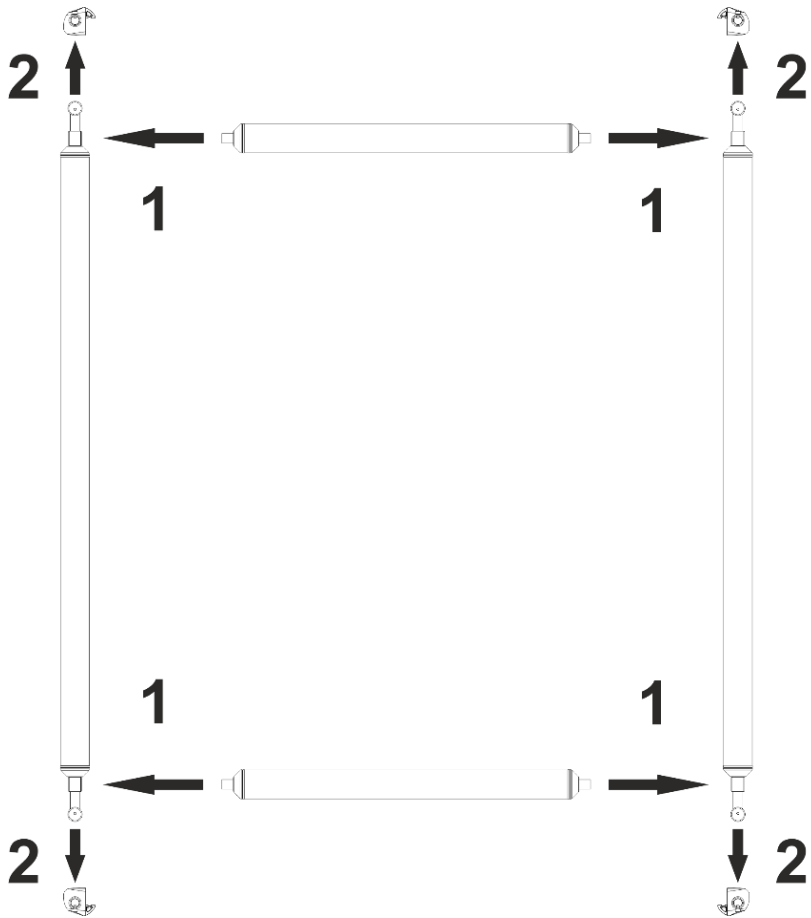

Fig. Installation of protector rollers (view from above)

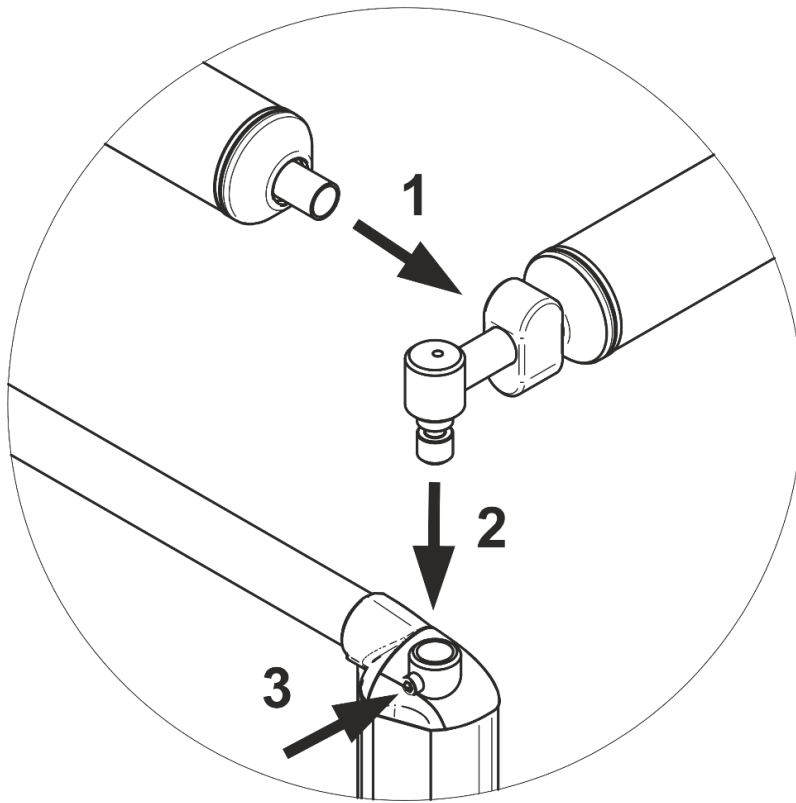

Fig. *Installation of protector rollers (view from above)*

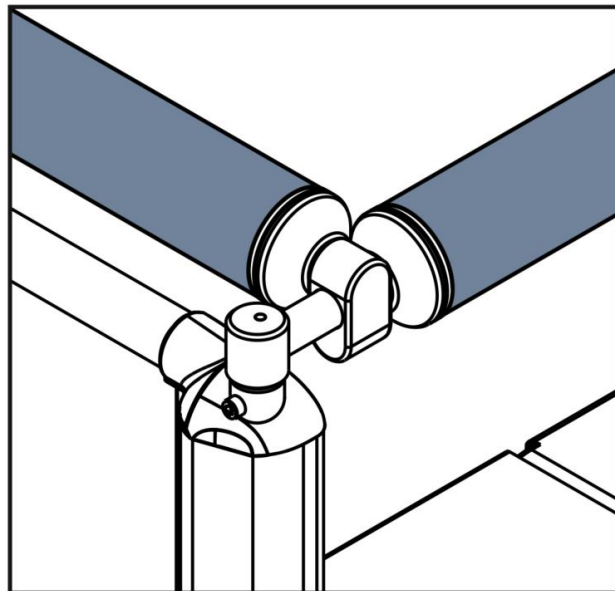

Fig. *Fixed protector rollers on the upper corner of the bed*

The protector may be removed as follows:

- 1) Unscrew a safety screw on the one upper corner of the bed (position 1 on the picture).
- 2) Remove longer roller from the bushing on this upper corner of the bed (position 2 on the picture).
- 3) Raise this longer roller on this upper corner of the bed carefully and remove pin of the shorter roller from the bushing of this longer roller (position 3 on the picture).
- 4) Hold the shorter roller released at one end and insert pin of the longer roller into the bushing on this upper corner of the bed again.
- 5) Remove pin of the shorter roller on the opposite side from the bushing in order to remove the shorter roller from the assembled protector.
- 6) Go to the opposite bed end and release the second shorter roller according to instructions in points 1) to 5).
- 7) Remove the protector longer rollers from bushings on the upper corners of the bed.
- 8) Screw each of 4 safety screws on the upper corners of the bed.
- 9) Ensure that each of 4 safety screws on the upper corners of the bed is tightened. Use an allen key (size 5 mm) to tighten screws with torque 5+2 Nm.
- 10) Store all four protector rollers safely.

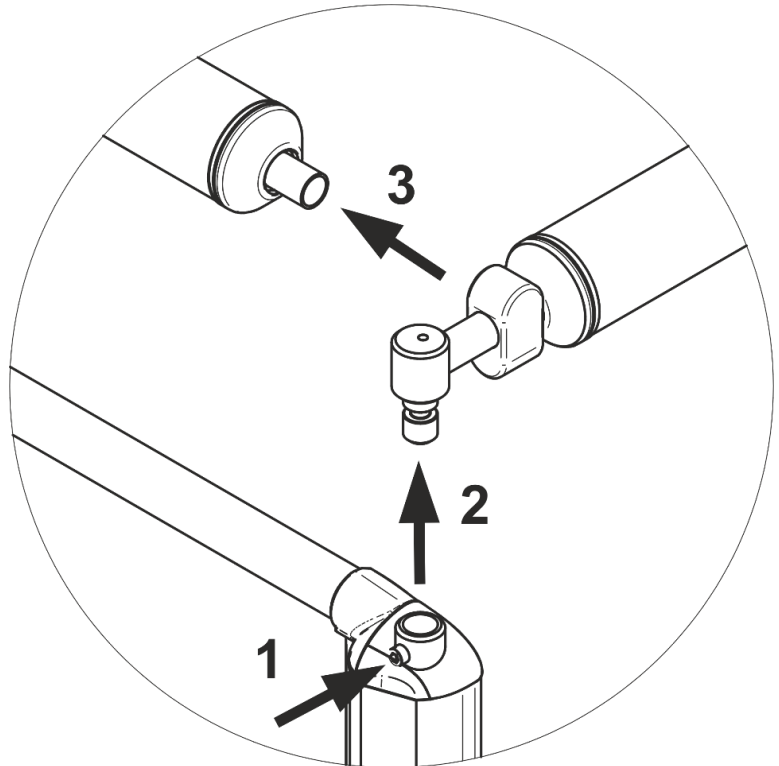

Fig. Removal of protector rollers

13 Mattress

! WARNING!

Risk of patient injury due to use of inappropriate mattress!

- Only use mattress with dimensions recommended by manufacturer!
- Injury may occur if smaller mattress than recommended is used!

The manufacturer recommends to use mattress with dimensions 142x70x10 cm for the pediatric bed Tom 2. It is possible to order the mattress CliniCare 10P from Linet®.

13.1 CliniCare 10P

Mattress CliniCare 10P for Tom 2 are designed for child patients on the pediatric departments. CliniCare 10 Pediatric is double layer mattress. It has bottom cold polyurethane foam and top Viscoelastic foam. There is profiling on the bottom and top surface is perforated.

13.2 Rotating of the mattress

! CAUTION!

Risk of damaging the mattress due to improper maintenance!

- The mattress is one-sided. The mattress cover must be oriented with printed labels on the top. Top and bottom side of the cover cannot be replaced. The orientation of cover must be preserved according to the zip cover placement (see following picture), which prevents the mattress core from the unwanted penetration by liquids and dirt. One-sided mattresses cannot be turned. It is necessary to rotate the mattress in periodical intervals to preserve qualitative properties of the mattress (recommended interval is once a month). For better orientation the cover may have numbers 1 and 2 printed on the head and foot end. This is preventive measure against permanent deformation of the core.

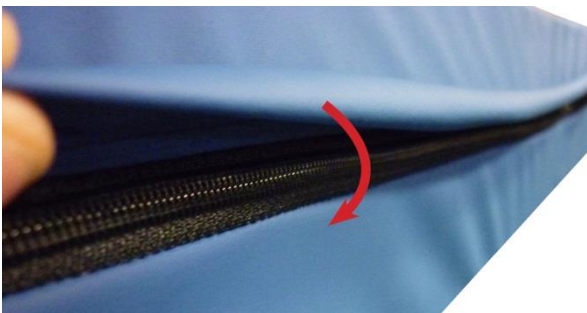

Fig. Proper placement of the zip cover (cover over the zip)

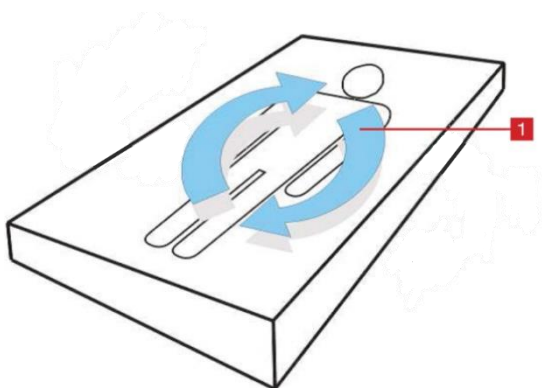

Fig. Rotating of the mattress

1. **Rotating** - This means replacing the head and foot end of the mattress.

13.3 Technical specification of the mattress

Parameters	CliniCare 10 P
(Foam)	
Material	Polyurethane foam and Visco foam
Load limit	up to 75 kg
Mattress weight	6 kg
(Cover)	
Color	blue/gray
Zipper	360°
Flap over zipper	yes
Transport mounts	yes
Conjunction	welding, sewing
Waterproof	yes
Vaporpermeable	yes
Antibacterial	yes
Fire resistance	Testing according to 16 CFR 1632 and 16 CFR 1633

13.4 Mattress cleaning and disinfectants

- ❖ Mattress covers can be disinfected with most common disinfectants.
- ❖ If disinfecting is not required, cleaning with soap and water should be enough to remove dirt stains.
- ❖ Cleaning and disinfecting products based on solvent, bleach, abrasives or high alcohol concentrations can damage this product.
- ❖ Antimicrobial effect can be reduced by washing.

CAUTION!

Risk of damaging the mattress due to improper cleaning!

- ➔ Mattress cover must be cleaned separately (after removing the mattress core from its cover) and letting it dry out. The foam core cannot be cleaned by any fluids or disinfectants.
- ➔ Do not use pressure or steam cleaners.
- ➔ Follow the instructions and observe the dosages recommended by manufacturer.
- ➔ Ensure that disinfectants are selected and applied by qualified hygiene experts only.

CAUTION!

Risk of damaging cover the mattress due to improper cleaning of the cover!

- ➔ Do not use agents containing aldehydes or phenols for cleaning, disinfection and washing!
- ➔ Maximal allowed concentration of chlor based disinfectants is (Chloramine) is 0,5%. After the disinfection procedure it is necessary to wash the surface of the cover with clean water and dry it thoroughly.

13.4.1 General Guidance

For safe and gentle cleaning:

- ❖ Do not use any strong acids or alkalines, (optimum pH range 6 – 8. Do not exceed pH of 9).
- ❖ Only use detergents that are suitable for cleaning medical equipment.
- ❖ Do not use abrasive powders, steel wool, or other material and cleaning agents that might damage the mattress. Do not scrub mattress surface.
- ❖ Never use any corrosive or caustic detergents.
- ❖ Never use detergents that deposit calcium carbonate.
- ❖ Never use detergents with solvents that might affect the structure and consistency of the plastics (benzene, toluene, acetone etc.).
- ❖ Use only hospital-approved cleaners and observe local directives concerning infection control.
- ❖ Always rinse with water after cleaning and dry thoroughly before use.
- ❖ Observe local directives concerning infection control.

Mattress parts to be cleaned	Recommended Cleaning Agents (General cleaning)
Top Cover , Bottom Cover	Standard hospital detergents, Alcohol or Quaternary Ammonium based disinfectants, Chlorine based disinfectants containing up to 5000 ppm Chlorine, followed by rinsing with water and drying thoroughly before use.
	Decontamination: Blood spills/C-diff. etc Chlorine based disinfectants containing up to 5000 ppm Chlorine. Dwell time on surface at 5000 ppm of 5 minutes, followed by rinsing with water and drying thoroughly before use.
Mattress Core	Do not clean!

Due to the variety of laundry equipment, chemicals and conditions in use, customers should satisfy themselves through pre-testing. It is essential that cover be thoroughly rinsed and dried after all cleaning procedures and before storage or reuse. Wet or damp PU surfaces are more prone to mechanical damage than when dry.

As stated above, after application of a suitable cleaner, the surface must be rinsed with water and dried before use. (Even if the cleaner instructions say that this is not required). This prevents a build-up of chemicals on the mattress surface which could be reactivated during use and affect biocompatibility.

NOTE: Continued use of high concentration, chlorine-based disinfectants may significantly reduce the performance and the working life of a coated material.

Type of Cleaning	Parts to be cleaned
Routine Cleaning and Disinfection	external of mattress cover
Full Cleaning and Disinfection	external of mattress cover

13.4.2 Routine Cleaning and Disinfection

Cleaning the mattress:

- ❖ Check mattress cover top for any signs of damage or for liquid ingress.
- ❖ Replace or repair and completely disinfect mattress cover top if damaged. Also check if the mattress core is not contaminated. In case of core contamination, do not use the mattress and dispose the core.
- ❖ Leave mattress cover on mattress.
- ❖ Clean with 50 °C warm water with cleaning detergent.
- ❖ Rinse mattress with cold water.
- ❖ Let mattress air dry or wipe dry.
- ❖ Wipe mattress with disinfectant and rinse mattress with cold water.
- ❖ Let mattress dry or wipe dry.

13.4.3 Complete Cleaning and Disinfection

Cleaning Top/Bottom Cover:

Use standard hospital detergents, Alcohol based cleaners or Quaternary Ammonium based disinfectants. Suitable Chlorine based cleaners can be used at a concentration of 1000ppm. Stronger concentrations of chlorine can be used if required, (up to 10,000ppm), with a maximum dwell time of five minutes followed by rinsing with water and drying thoroughly before use.

After application of a suitable cleaner, the surface should be rinsed with water and dried before use. (Even if the cleaner instructions say that this is not required). This prevents a build up of chemicals on the mattress surface that could reactivate during use and affect biocompatibility.

Cleaning the mattress:

- ❖ Check mattress cover top and base for any signs of damage.
- ❖ Replace or repair and completely disinfect mattress cover top and base if damaged. Also check if the mattress core is not contaminated. In case of core contamination, do not use the mattress and dispose the core.
- ❖ Leave mattress cover on mattress.
- ❖ Clean all mattress cells and pipes with 50 °C warm water with cleaning detergent.
- ❖ Rinse mattress with cold water.
- ❖ Let mattress air dry or wipe dry.
- ❖ Wipe mattress with disinfectant.
- ❖ Rinse mattress with cold water.
- ❖ Let mattress air dry or wipe dry.

Machine washing of the top/base mattress covers:

- ❖ Remove cover (see Removing the Mattress Cover).
- ❖ If machine washing mattress top/base covers, the temperature should be raised during the wash cycle, to 65°C/149°F, for 10 -15 minutes, or 71°C/160° F, for 3 - 10 minutes, using hospital approved detergents and rinsing agents.
- ❖ Dry cover in tumble dryer at low temperature.

NOTE: *Maximum wash temperature 75°C/167°F.*

13.4.4 Mattress Core

The entire core of the mattress does not require any major cleaning. The core does not need disinfection. Once a month it is recommended to ventilate the mattress core (remove the mattress cover and leave the mattress core on ventilated area for 12 -24 hours). The mattress core cannot be washed by water or by disinfection.

14 Cleaning and Disinfection of the Bed

WARNING!

Risk of injury when working on the bed!

- Prior to assembly, disassembly, cleaning and maintenance, ensure that all adjustment functions are locked.
- Ensure the bed is disconnected from the mains during cleaning process.
- Pay extra attention when cleaning any movable or controlling mechanisms of the bed to prevent involuntary activation, entrapping or crushing.
- Cleaning should be entrusted to the person who has been trained to control the bed.

WARNING!

Risk of damaging the bed due to use of incorrect cleaning detergents or cleaning processes!

- The bed is not designed for machine washing.
- The bed is not designed for cleaning by spraying, showering nor for pressure or steam cleaners.
- The selection of cleaning detergents/disinfections and their correct concentration is responsibility of responsible person in charge of cleaning/disinfection in accordance with the informations provided in this manual.
- Never use germicidal or other radiants for disinfection of the bed, if those radiants act directly on the bed.
- Follow these instructions and follow the prescribed dosage by the manufacturer of cleaning detergents.
- Not following recommended processes may result in damaging or deterioration of the bed condition.

14.1 Safety Instructions for Cleaning and Disinfection of the Bed

Preparation for cleaning:

- ❖ Drive the bed on a place where the cleaning process will be performed and then brake the bed.
- ❖ Position the mattress platform to its highest positions and also position the back rest and thigh rest parts so the back side of those parts are accessible for cleaning.
- ❖ Lock all adjustment functions of the bed to prevent involuntary adjustment of the bed or injuries during cleaning.
- ❖ Disconnect the bed from the mains.
- ❖ Check if all connectors are properly fixed (controllers, actuators and control unit).

Recommendations for cleaning:

- ❖ Only use detergents designed for cleaning the medical technologies.
- ❖ Dilute the detergents in accordance with instructions from manufacturer of detergents.
- ❖ Never use any strong acids or bases. Optimal pH range is 6-8.
- ❖ Never use abrasive powders, steel wool or other materials and detergents that may damage the surface of the bed.
- ❖ Never use detergents with solvents that may affect the structure and consistency of the plastic parts (benzene, toluene, acetone etc.).

Cleaning process:

- ❖ Clean by wiping the bed with damp, well-wrung textile material.
- ❖ The detergent can be applied by spraying on bed or on the textile material.
- ❖ Perform cleaning and disinfection of the bed in the appropriate range. The range of cleaning and disinfection should be distinguished according to the degree of contamination of the bed and the cleaning mode (daily, before changing patient or complete).
- ❖ Electronic parts that may be contaminated clean carefully and only their outer side. Never open those connectors due to cleaning or disinfection. Those components should not be exposed to prolonged or continuous exposure to moisture.
- ❖ Let the bed dry completely after cleaning or disinfection process.

- ❖ After drying the bed place the mattress back on the mattress platform.
- ❖ After drying the bed check functions of the bed.

14.2 General Instructions for Cleaning and Disinfection

14.2.1 Daily Cleaning

It is recommended to clean all parts of the bed which are touched by patient or personnel (e.g. siderails, bed ends, handset, lifting pole etc.) and all handles, all control elements and accessory rails.

14.2.2 Cleaning before Changing Patients

It is recommended to completely clean and disinfects all parts of the bed which are touched by patient or personnel (see Daily Cleaning), mattress platform, columns, undercarriage covers and mattress.

14.2.3 Complete Cleaning / Cleaning before First Use

It is recommended to clean the bed completely before the first use and then at least once in 4-8 weeks.

14.2.4 Cleaning of Spilled Fluids

Spilled fluids should be cleaned as soon as possible. Always disconnect the bed from mains before cleaning the spilled fluids. Some fluids used in health care may cause permanent stains.

14.2.5 Damaged Foam Mattress

Mattress should be periodically checked for cracks, holes or cracks that may affect the integrity, water resistance or resistance to infections of the cover. Contact the service department of the manufacturer according to scope of damage to cover.

14.3 Choosing of Detergents or Disinfections

CAUTION!

Risk of damaging the bed due to use of incorrect detergent!

- Always consult choosing of the detergent and its dilution with manufacturer of the detergents according to the material table below.

Part of bed – Tom 2	Material (*)	Daily C&D	Changing patient C&D	Complete C&D
Telescopic siderails				
■ Telescopic bars	PA, 15% GF, ALU	☑	☑	☑
■ Releasing mechanism	PA, 15% GF	☑	☑	☑
■ Upper bar	ALU, POM	☑	☑	☑
■ Bottom bar	S	☑	☑	☑
Bed ends				
■ Board	PC	☑	☑	☑
■ Corners	S, PA, 15% GF	☑	☑	☑
■ Frame	ALU, S, POM	☑	☑	☑
Controllers	ABS	☑	☑	☑
Mattress platform covers	ABS	☒	☑	☑
Undercarriage cover	ABS	☒	☑	☑
Telescopic columns	ALU	☒	☑	☑
Mains cable	PU	☒	☒	☑
Undercarriage frame	S	☒	☒	☑
Castors	S, PP, TG	☒	☒	☑
Actuators	ABS, ALU	☒	☒	☑

Material (*)	Shortcut
Akrylonitrilbutadienstyren	ABS
Aluminium	ALU
Glass fibre	GF
Polyamide	PA
Polycarbonate	PC
Polyoxymethylene	POM
Polypropylene	PP
Polyurethane	PU
Steel	S
Thermoplastic Gum	TG

15 Troubleshooting

DANGER!

Danger to life due to electric shock!

- ➔ If a fault occurs ensure the electric motor, power box and other electrical parts checked by qualified personnel only.
- ➔ Do not open protective covers of the electric motor or power box.

Error/Fault	Cause	Solution
Adjusting with position buttons not possible	GO button was not pressed	Press the GO button.
	Drive motors have no power Defective drive motors Defective battery	Check the mains connection. Notify the service department.
	Plug inserted incorrectly	Insert the mains plug correctly.
	Faulty power box	Notify the service department.
	Faulty control element	Notify the service department.
Faulty mattress platform height/tilt adjustment	There is an object on the undercarriage cover	Remove the object.
	Drive motors have no power Defective drive motors Defective battery	Check the mains connection. Notify the service department.
	Plug inserted incorrectly	Insert the mains plug correctly.
	Faulty power box	Notify the service department.
	Faulty control element	Notify the service department.
Lowering backrest from the upright position not possible	Object under the backrest or in the drive mechanism	Remove the object.
	Locking handle is defective	Notify the service department.
Adjusting siderails not possible	The siderail lock is dirty	Clean the locking mechanism.
	Locking handle is defective	Notify the service department.
Faulty brakes	The brakes are blocked by dirt	Clean the brake system.
	The brake mechanism is defective	Notify the service department.

16 Maintenance

WARNING!

Risk of injury when working on the bed!

- Ensure that the bed is disconnected from the mains connection prior to assembly, disassembly and maintenance.
- Ensure that the castors are locked prior to assembly, disassembly and maintenance.

WARNING!

A defective bed can cause injuries!

- A defective bed should be inspected and repaired immediately.
- If the defect cannot be repaired, do not use the bed.

CAUTION!

Incorrect maintenance can damage the bed!

- Ensure maintenance is performed by a LINET® service engineer service or trained hospital technicians only.

16.1 Maintenance Work

- ❖ The connector replacement should only be carried out by service personnel trained by LINET®. For service related instructions, please refer to the service documentation.
- ❖ Ensure the following maintenance work is performed every 12 months by the manufacturer or by a qualified service organisation trained and certified by the manufacturer. Service documentation and electrical schemes are available for qualified service organisation trained by LINET®.
- ❖ The manufacturer will provide the service organisation with service training certification to confirm the organisation is qualified to carry out maintenance on LINET® products.
- ❖ Do not use the bed if any malfunction or defect occurs. In this case contact the manufacturer or service organisation immediately.

16.1.1 Spare Parts

The product label is located on the longitudinal rail of the mattress platform frame. The product label contains information required for product queries and ordering replacement parts.

Information about spare parts is available from:

- Customer service
- Sales
- Our technical support department

16.1.2 Completeness

- ❖ Perform a visual check (with delivery note if necessary).
- ❖ Have any missing parts replaced.

16.1.3 Wear

- ❖ Check all bolts and tighten if necessary.
- ❖ Check all locking mechanisms.
- ❖ Check the bed for wear, scratches or rub marks.

- ❖ Eliminate the cause if necessary.
- ❖ Have any defective parts replaced.

16.2 Functioning

- ❖ Check that all bed adjustments reach the maximum position.
- ❖ If necessary, clean or replace any worn areas and parts.

16.2.1 Electric Control

Plug Connections

- ❖ Replace O-rings on connectors.
- ❖ Check the plug connections for dirt and defects.
- ❖ Clean or replace if necessary.
- ❖ Check the plug connectors are properly seated.

Motors

- ❖ Check motor movement (adjust bed positions). Check for incorrect and interrupted movements.
- ❖ Have defective motors replaced if necessary.
- ❖ Check cables for signs of wear and entanglement.
- ❖ Install new cable or replace the motor if necessary.

Battery

- ❖ Check the battery is working properly (disconnect the bed from the mains).
- ❖ Replace the battery if necessary.

16.2.2 Castors

- ❖ Clean the castors completely.
- ❖ Grease the castors if necessary. Use Caro EP 2 by DEA or an equivalent grease
- ❖ Check the castors work properly.
 - Forward Movement
 - Unrestricted Movement
 - Braked
- ❖ Have the brakes adjusted if necessary.
- ❖ Have any defective castors replaced.

16.2.3 Accessories

- ❖ Check all accessories (for example, lifting pole, siderails, infusion stand, etc.) are working properly.
- ❖ Replace if necessary.

16.2.4 Safety checks

WARNING!

Incorrect safety checks can cause injuries!

- ➔ Ensure that safety checks are performed by qualified or authorised personnel certified by the manufacturer.
- ➔ Ensure that the safety checks are recorded in the service and maintenance log of customer.

WARNING!

A defective bed can cause injuries!

- ➔ A defective bed must be inspected and repaired immediately.
- ➔ If the defect cannot be immediately repaired, do not continue to use the bed.

In accordance with the Medical Devices Operator Ordinance, the operator is required to perform a technical safety check on the hospital bed every 12 months.

The procedure for performing the safety check is stipulated in IEC 62353.

NOTE *Manufacturer will make available on request circuit diagrams, component part lists, descriptions, calibration instructions, or other information which will assist the user's appropriately qualified technical personnel to repair those parts of bed which are designated by the manufacturer as repairable.*

17 Disposal

17.1 Environmental Protection

LINET® is aware of the important role that the protection of our environment plays for future generations.

The materials of this product are environmentally compatible. It does not contain hazardous substances on the basis of cadmium, mercury, asbestos, PCB or CFC. Noise emissions and vibrations meet the directives for healthcare facilities. LINET® has taken care to ensure all wood used in the production of its bed systems is responsibly source (Mahogany, Jacaranda, Ebony, Teak or wood from Amazonian / rainforests are not used.

Packaging materials are produced according to the respective directives. Please ensure packaging materials are disposed of according to the symbols displayed and taken to an authorised disposal location.

The product consists of recyclable steel, plastic and electronic components.



17.2 Disposal

- ❖ Dispose of the bed or its components in accordance with local laws and regulations:
 - After using the bed
 - Following maintenance and installation work
- ❖ Hire an approved waste disposal company for disposal.

18 Warranty

LINET® will only be held responsible for the safety and reliability of products that are regularly serviced and used in accordance with the safety guidelines.

Should a serious defect arise that is in contrary with purpose of the bed:

- ❖ Do not continue to use the bed.

Warranty duration is subject to individual purchasing agreements with a minimum length of 12 months.

The warranty covers all material and manufacturing-related failures and errors. Failures and errors caused by incorrect use and external effects are not covered. Justified complaints will be fixed free of charge during the warranty period. Proof of purchase, with the date of purchase, is required for all warranty service. Our standard terms and conditions apply.

19 Technical Specifications

All technical data are rated data and are subject to construction and manufacturing tolerances.

19.1 Basic Specification and Bed Dimensions

Dimensions of the bed	164,1 cm x 83 cm
Mattress dimensions	142 cm x70 cm
Maximum Height of Mattress	10 cm
Siderail dimensions	140 cm x 90 cm
Siderail Height above Mattress Platform (without Mattress)	80 cm
Maximal clearance underneath the bed	13 cm
Mattress Platform Height Adjustment	58 cm – 83 cm
Maximum Back rest Angle	40°
Auto-regression	11 cm / 0 cm
Trendelenburg Position	15°
Reverse Trendelenburg Position	15°
Weight of bed without mattress and without accessories	135 kg
Safe Working Load (including Mattress and Accessories)	75 kg
Maximum Patient Weight	50 kg

19.2 Environmental conditions

Use conditions	
■ Temperature	10 °C — 40 °C
■ Humidity	30% — 75%
■ Atmospheric Pressure	795 hPa — 1060 hPa
Storage and Transport Conditions	
■ Temperature	-20°C — 50°C
■ Humidity	20% — 90% (non-condensing)
■ Atmospheric Pressure	795 hPa —1060 hPa

19.3 Electrical Specification

DANGER!

Danger to life due to electric shock!

- ➔ Ensure that maintenance and service of electrical parts are performed only by qualified personnel if the bed is disconnected.

Input Voltage	120 V~, 50/60 Hz
Maximum Power Input	370 VA
Ingress Protection	IP X4
Safety Class	Class I (with type B applied parts)
Electrical Motor Duty Cycle	max 2 minutes ON / 18 minutes OFF
Battery	Pb ACCU 2 x 12 V / 1,2 Ah / Fuse 15A
Fuse	2x T3.15A L 250 V for 100-127 V version

NOTE Only qualified technical personnel is authorized to change fuses, tool and fuses of the same type are required

NOTE Upon request, LINET® can deliver hospital beds with electrical specifications that comply with regional standards (custom voltage, different mains plugs).

19.4 Electromagnetic compatibility

Bed is intended for hospitals except for near active HF surgical equipment and the RF shielded room of a medical system for magnetic resonance imaging, where the intensity of EM disturbances is high.

Bed has defined no essential performance.

WARNING!

It is recommended to avoid the use of this device next to or in block with other device, because it could lead to improper operation. If such use is needed, this device and the other equipment should be under surveillance to verify proper operation.

List of used cables:

1. **Mains cable**, maximum length 6 m
2. **ACP Supervisor control panel**, maximum length 3m
3. **Handset**, maximum length 3m

WARNING!

Use of the accessories, converters and other cables, than specified and provided by manufacturer of this bed could lead to increase of electromagnetic emission or lower the electromagnetic immunity of this bed and lead to improper operation.

⚠ WARNING!

Mobile RF communication device (including end use devices like antenna cables and external antenna) should not be used closer than 30 cm (12 inches) from any part of this bed Eleganza 1, including cables specified by manufacturer. Otherwise this could lead to deterioration of functionality of this bed.

⚠ WARNING!

Do not overload the bed (SWL), respect the duty cycle (INT.) and consider chapter 15 Maintenance in order to maintain the basic safety with regard to electromagnetic disturbances for the expected service life.

Manufacturer instructions – electromagnetic emissions

Emission test	Compliance
RF emissions CISPR 11	Group 1
RF emissions CISPR 11	Class B
Harmonic emissions IEC 61000-3-2	Class A
Voltage fluctuations / flicker emissions IEC 61000-3-3	Complies

Manufacturer instructions – electromagnetic susceptibility

Immunity Tests	Compliance level
Electrostatic discharge (ESD) IEC 61000-4-2	± 8 kV for contact discharge ± 15 kV for contact discharge
Radiated RF IEC 61000-4-3 Proximity fields from RF wireless communications equipment IEC 61000-4-3	3 V/m 80 MHz – 2,7 GHz 80 % AM at 1 kHz See Table 1
Fast electrical transients / burst IEC 61000-4-4	±2 kV for power line repetition frequency 100 kHz
Surge IEC 61000-4-5	± 1 kV Line-to-line ± 2 kV Line-to-ground
Conducted RF IEC 61000-4-6	3 V (0,15 MHz – 80 MHz) 6 V in ISM bands between 0,15 MHz and 80 MHz 80 % AM at 1 kHz
Power frequency (50/60 Hz) magnetic field IEC 61000-4-8	30 A/m
Voltage dips, short interruptions on power supply input lines IEC 61000-4-11	0 % U_T ; 0,5 cycle At 0°, 45°, 90°, 135°, 180°, 225°, 270° a 315° 0 % U_T ; 1 cycle and 70 % U_T ; 25/30 cycle Single phase: at 0° 0 % U_T ; 250/300 cycle

Table 1 – IMMUNITY to RF wireless communications equipment

Test frequency (MHz)	Band (MHz)	Service	Modulation	Immunity test level V/m
385	380 - 390	TETRA 400	Pulse modulation 18 Hz	27
450	430 - 470	GMRS 460, FRS 460	FM \pm 5 kHz deviation 1 kHz sine	28
710 745 780	704 - 787	LTE band 13, 17	Pulse modulation 217 Hz	9
810 870 930	800 - 960	GSM 800/900, TETRA 800, iDEN 820, CDMA 850, LTE band 5	Pulse modulation 18 Hz	28
1 720 1 845 1 970	1 700 - 1 990	GSM 1800; CDMA 1900; GSM 1900; DECT; LTE band 1, 3, 4, 25; UMTS	Pulse modulation 217 Hz	28
2 450	2 400 - 2 570	Bluetooth, WLAN, 802.11 b/g/n, RFID 2450, LTE band 7	Pulse modulation 217 Hz	28
5 240 5 500 5 785	5 100 - 5 800	WLAN 802.11 a/n	Pulse modulation 217 Hz	9

NOTE There are applied no deviations to requirements of IEC 60601-1-2 ed. 4

NOTE There are no known other measures for keeping the basic safety based on EMC phenomena.

NOTE Beds equipped with communication module meet standard for IEEE 802.11 b/g/n (2400,0 MHz – 2483,5 MHz, modulation DSSS (IEEE 802.11 b), OFDM (IEEE 802.11 g/n) 20MHz bandwidth, EIRP = 0,34 W)