

ActiveCare

Medical



Medalist 450 Power Wheelchair Owner's Manual

Table of Contents



1.	Preface	2
2.	Safety Notices	3
3.	Electromagnetic Interference	4
4.	Parts	5
5.	Initial Assembly	6
6.	Comfort Adjustments	10
	Controller Position	10
	Armrest Width	10
	Footplate Height.....	10
	Seat Height	11
7.	Operation	12
	General Information	12
	Controller.....	12
	Freewheel Mode	13
	Security Functions.....	13
	Transporting Your Chair	13
	Positioning Belts.....	14
	Use on Inclines.....	14
	Batteries	15
	Motor	15
	Electrical Brakes	16
	Tires	16
	Troubleshooting.....	16
8.	Batteries & Charger	17
	Charger Features.....	17
	Operation Instructions	17
	Usage Environment.....	18
	Notes.....	18
9.	Specifications	19
10.	Limited Warranty	20
	Product Registration.....	22

Preface

Please read this owner's manual before using the power wheelchair. Improper use of the power wheelchair could result in harm, injury or traffic accidents.

This owner's manual includes operation instructions for every aspect of the power wheelchair, assembly instructions, as well as instructions for how to deal with possible accidents.

The symbols used in this manual are explained below. Read carefully, especially the parts marked with these symbols:

	Warning	Improper usage could lead to death or serious injury
	Caution	Improper usage could lead to injury and/or damage to your power wheelchair.
	Suggestion	Follow these instructions to keep the status of the power wheelchair working well and ease your operation.

This manual includes the repair and maintenance record chart and warranty. Please keep it in a proper place or on the wheelchair.

If someone else uses the wheelchair, please be sure to give the instruction manual to him or her.

As designs change, some illustrations and pictures in the manual may not correspond to the wheelchair that you purchased. We reserve the right to make design modifications.

The manufacturer disclaims all responsibilities for any personal injury or property damage which may occur as a result of improper or unsafe use of its products.

Safety Notices

1. Always fully charge your power chair before operating.
2. Always make sure the power is off when getting in and out of the power chair.
3. Always make sure the clutch levers are engaged (parallel to the wheels) before getting in or out of the wheelchair.
4. To prolong the life of the battery, it is suggested you charge the battery after every trip. If you do not drive it for long periods of time, charge it at least once per month.
5. If the battery gauge goes to RED, charge the battery as soon as possible. If the battery is totally discharged, it could be damaged, and/or its life could be shortened.
6. As the battery ages and deteriorates, the battery power will decrease faster.
7. In cold weather, the battery capacity will be less.
8. When you are charging the battery, please make sure that the input-voltage (115V/230V) switch on your charger matches your power source.
9. Avoid unnecessarily moving of the power chair.
10. Please fasten the seat belt, if included, while driving and check the proper position of the anti-tip wheel.
11. Our products function best at temperatures between 32-122° Fahrenheit.
12. Disassembling of controller, motor or charger by end user is prohibited; the dealer will not take any responsibility on these kinds of situations.
13. Prevent the controller, charger and battery from getting wet; this can cause a malfunction.
14. To ensure the user's familiarity with the power chair's operation, the new driver should practice driving in a spacious area, traveling forward, backward, left, right, using the brakes, and going both up and down slopes.
15. Please turn off the power chair when the chair is not in use and before charging the battery.
16. The following areas and conditions can be dangerous and should be avoided; darkness, dim lighting, steep slopes, rain, snow, shoulder of the road, slippery areas, etc.
17. Please do not drive your power chair at night without proper lighting.
18. Please do not lower the footplate to less than 2" above the ground, because accidents may occur due to insufficient ground clearance.
19. Keep your feet on the footplate at all times during operation and do not stand on the footplate. If your feet are in the improper position, you can be seriously injured.
20. When the power does not come on, recheck all connections and recharge if necessary.
21. Please check the screws under the joystick periodically and make sure they are not loose, and tighten them if needed.

Electromagnetic Interference

Power mobility products may be susceptible to electromagnetic interference (EMI), which is interfering energy emitted from sources such as:

- Cellular phones
- Wireless computer links
- Two-way radios
- Radio stations
- TV stations
- Amateur radio (HAM) transmitters
- Microwave signals
- Medium-range mobile transceivers used by emergency vehicles

This interference can cause the mobility power mobility product to release its brakes, move by itself, or move in unintended directions. It can also permanently damage the power mobility product's control system.

Every electronically-powered mobility scooter has a resistance to EMI – the higher the immunity level, the greater the resistance to EMI. Your power mobility product has been laboratory tested and is immune to EMI up to a level of 20 V/M.

Warning!

Following the warnings listed below should reduce the chance of unintended brake release or mobility power mobility product movement which could result in serious injuries.

1. Do not operate hand-held transceivers-receivers, such as citizens band (CB) radios, or turn ON personal communication devices, such as cellular phones, while the mobility power mobility products turned ON.
2. Be aware of nearby transmitters, such as radio or TV stations, and try to avoid getting close to them.
3. If unintended movement or brake release occurs, turn the mobility power mobility product OFF as soon as it is safe.
4. Be aware that adding accessories or components, or modifying the mobility power mobility product, may make it more susceptible to EMI.
5. Report all incidents of unintended movement or brake release to ActiveCare Medical, and note whether there were sources of EMI nearby.

Parts

MEDALIST 450

1. Backrest
2. Armrest
3. Joystick
4. Seat
5. Front Shroud
6. Front Caster
7. Footplate
8. Drive Wheel

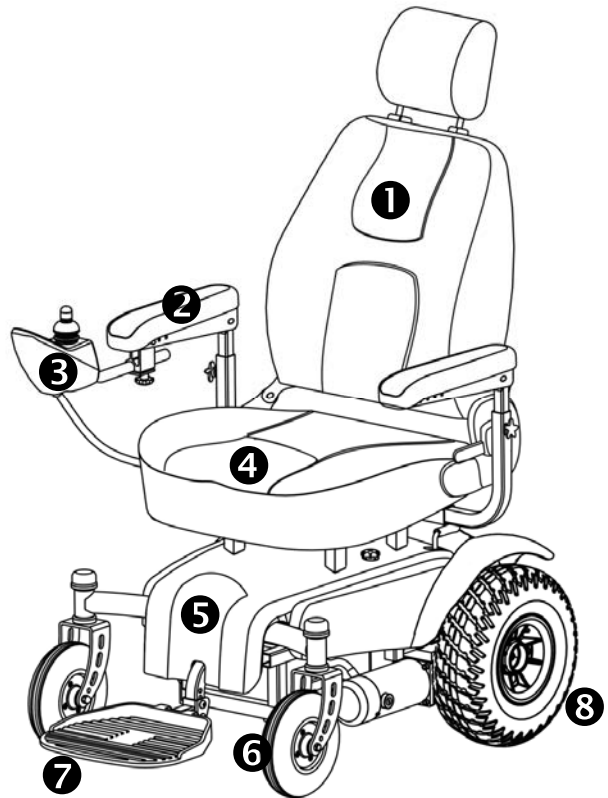

9. Anti-tippers
10. Battery Drawer

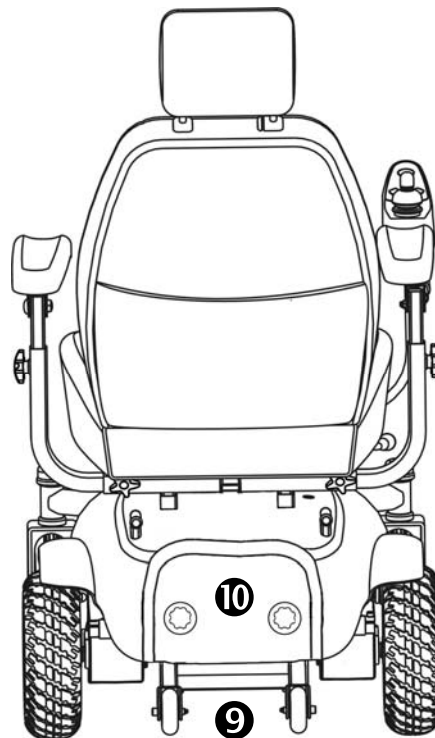

Initial Assembly

1. Loosen and remove the two knobs on the battery drawer cover found at the rear of the wheelchair.



2. Carefully remove the battery drawer cover.



3. Remove the bolts on either side of the battery compartment opening.



4. Loosen and remove the two knobs on top of the shroud.



5. Using the included Allen wrench, loosen the bolts on the rears of all four seat posts.

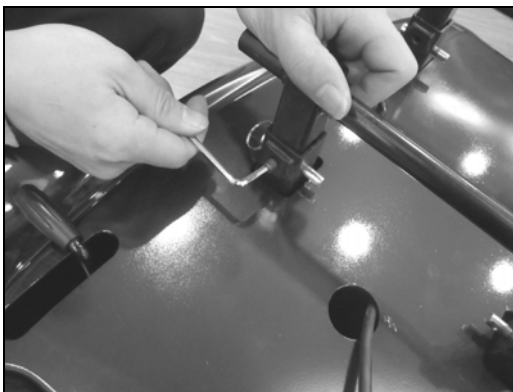

6. Remove the metal pins located on the sides of all four seat posts.



7. Remove both seat crossbars.

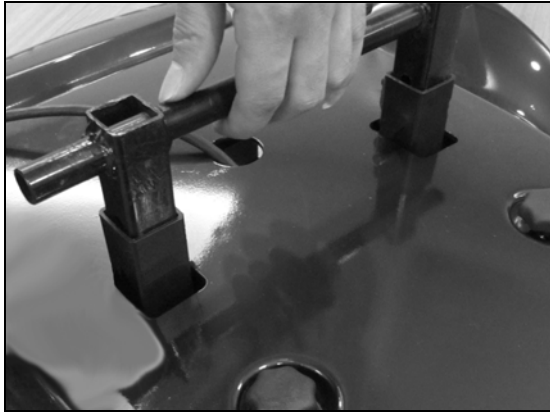

8. The upper shroud can now be removed by lifting it upward.



9. Connect the main battery harnesses to the main cable, connecting red to red and black to black.



10. Replace the upper shroud. The shroud must slide over the brake levers, which should be positioned in the engaged mode. Reaffix all hardware removed in previous steps.



For ease of service and replacement, the Medalist 450 is equipped with a slide-out battery drawer.

11A. To access the batteries using the drawer, first remove the pins locking the battery drawer to the wheelchair's main frame.



11B. The battery drawer can now be pulled outward to access the batteries.



12. To install the seat, insert the semi-circular cutouts onto the front seat crossbar so that the seat is leaning forward.

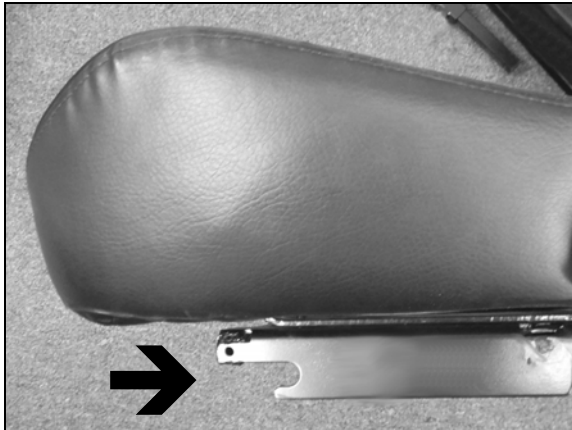

13. Carefully lower the rear end of the seat onto the rear seat crossbar until it snaps into place securely.

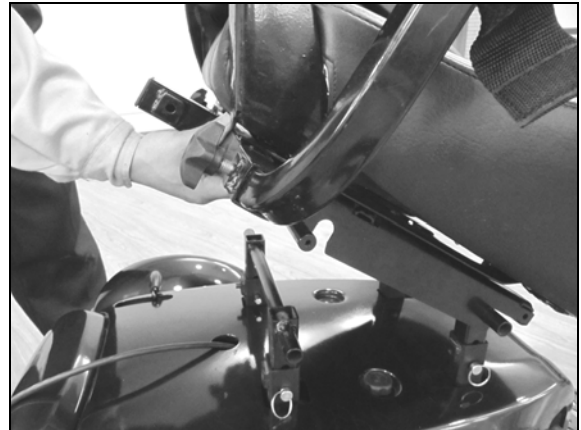

Warning! Only use the Medalist 450 with all four seat posts seat at the same height. Failure to do so may result in the chair tipping over, causing serious injury.

14. Insert the armrests into the attachment points in the seat frame so that the armrests face forward.

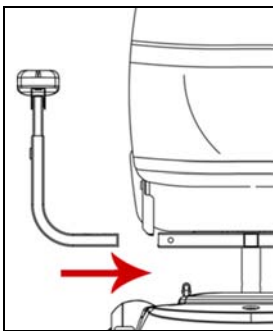

15. Insert and tighten the included star knobs to lock the armrests into place at the desired width.

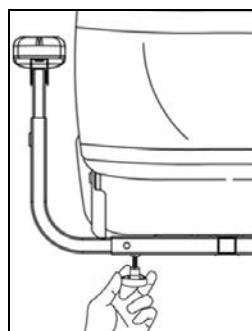

16. Affix the headrest to the top of the seat by inserting the headrest posts into the holes in the top of the seat.

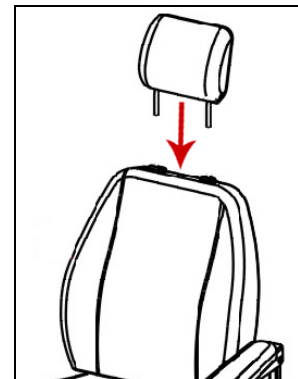

17. Plug the controller cable coming from the power base into the port of the rear of the joystick unit.



18. Insert the controller's square tube into the tube under the armrest. Tighten the bolt on the underside of the controller arm tube to hold it in place at the desired extension.

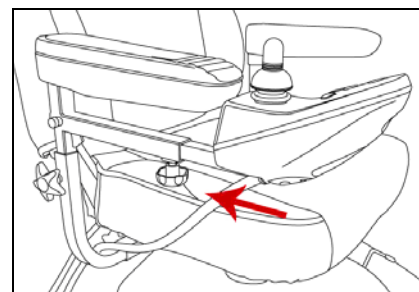

11. Fully charge the wheelchair's batteries by inserting the round charger connector into the battery charging terminal on the front of the wheelchair's controller and inserting the 3-pronged plug into a standard electrical outlet.

Ensure that the 115V/230V switch on the product's battery charger is set to 115V. If the switch is set to 230V, the batteries will not charge properly.

Full charging normally takes 6-8 hours, but can take as many as 10 hours depending on the batteries' charge level when starting and the ambient temperature.

Comfort Adjustments

CONTROLLER POSITION

The position of the controller can be adjusted by loosening the bolt on the underside of the controller arm and sliding the arm forward or backward to the desired position.

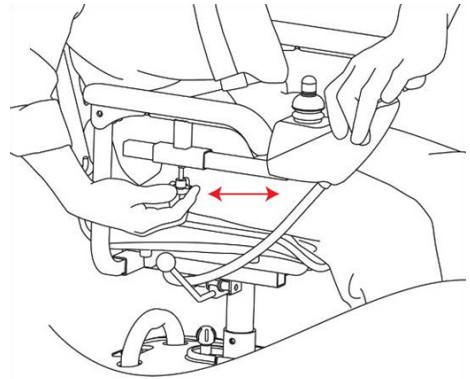

ARMREST WIDTH

The width of armrests can be adjusted by loosening the bolts on the underside of the armrests and sliding the armrests inward or outward to the desired width.

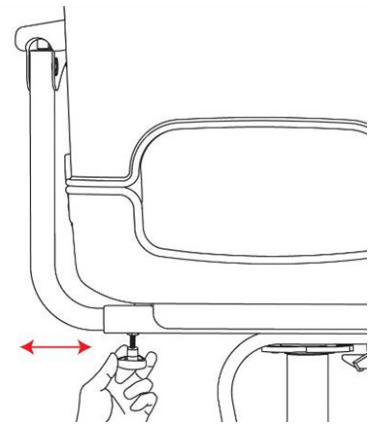

FOOTPLATE HEIGHT

The height of footplate can be adjusted to two positions. Remove the screws that hold the footplate to the wheelchair's frame, place the footplate at the desired height setting, and replace and fully tighten the screws.

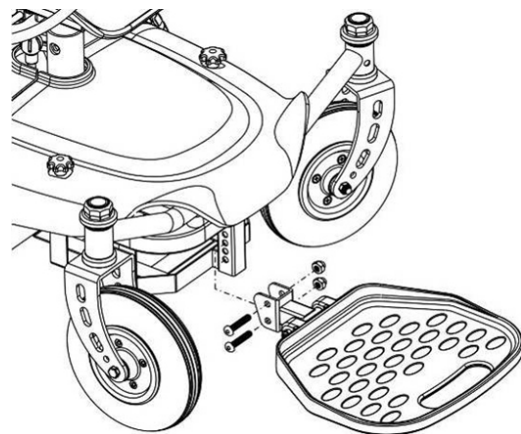

SEAT HEIGHT

The height of seat can be adjusted to three positions. Remove the seat by pulling the bar on the bottom rear of the seat's frame. Doing so will release the seat and allow you to tip the seat forward and then lift up to remove it from the wheelchair's base.

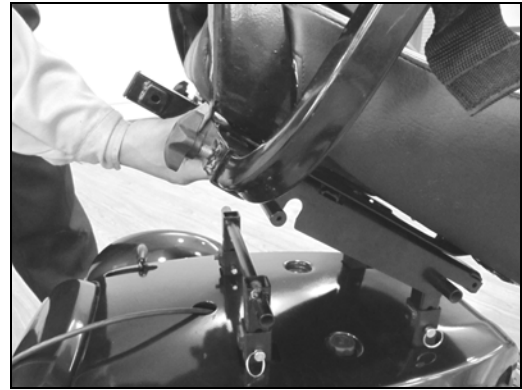

Using the included Allen wrench, loosen the bolts on the rears of all four seat posts.

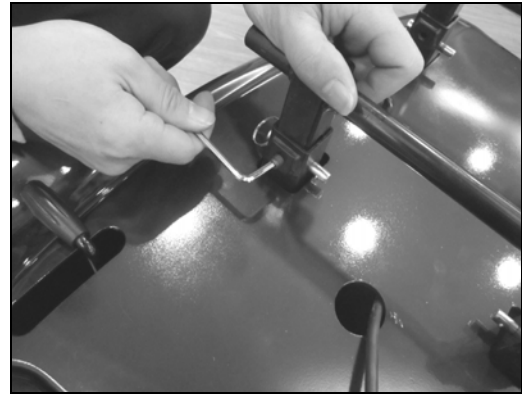

Remove the metal pins located on the sides of all four seat posts.



Raise or lower the seat crossbars to the desired height. Reinsert the metal pins so that they go completely through the seat posts and the crossbar. Retighten the four Allen bolts on the rears of the seat posts.

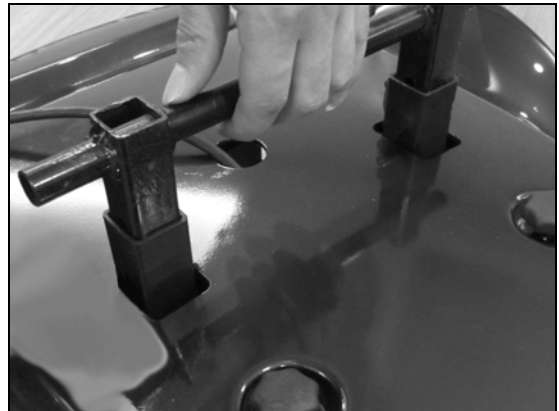

Warning! Only use the Medalist 450 with all four seat posts seat at the same height. Failure to do so may result in the chair tipping over, causing serious injury.

Operation

GENERAL INFORMATION

1. Make sure that the motor levers are in engaged mode. (Parallel to the wheels)
2. Once seated on the wheelchair, turn on the power (Press the power button). The battery gauge will turn on.
3. We suggest the new users operate the chair in low speed until comfortable with the chair and its use.
4. Start to steer, moving the joystick to drive forward, backward, left or right. If you want to stop the wheelchair, release the joystick—it will automatically return to the center position to stop the chair.
5. The chair's speed is automatically reduced by half when the chair is turning.
6. When driving the chair on a slope, push the joystick forward to keep the chair continuously climbing until you reach the top of the slope. While the chair is climbing a steep slope, position your body forward to prevent the front wheels from lifting.
7. When driving the chair down a slope, drive slowly and prepare for an emergency stop if you feel it difficult to control the chair. If the speed increases, release the joystick to slow down or to stop, then start again at a slower speed.

CONTROLLER

- | | |
|-----------------------------|-------------------------|
| 1. Joystick | 5. Battery Gauge Lights |
| 2. Error Sign | 6. Power On/Off |
| 3. Speed Down Button | 7. Buzzer Button |
| 4. Service Indicator Lights | 8. Speed Up Button |

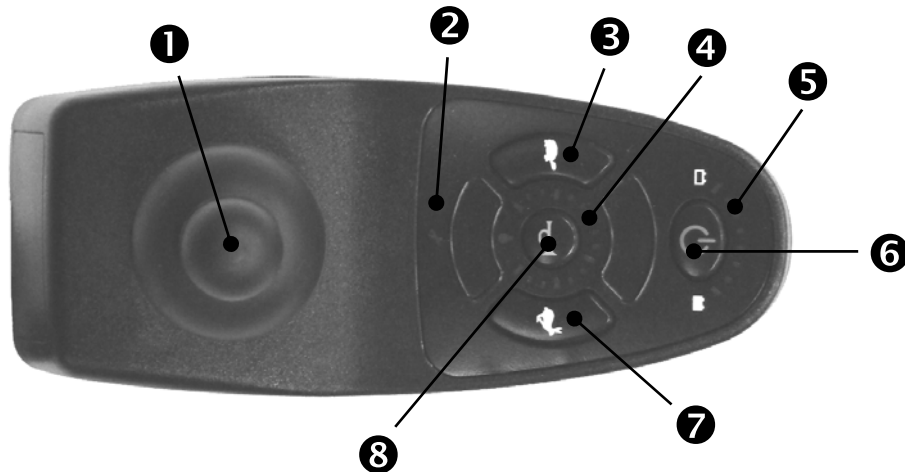

Battery Gauge

When the power chair is turned on, the battery gauge will light up as indicated below:

Green lights: the battery has full capacity.

Orange lights: do not drive power-chair for a long trip.

Red lights: the power-chair should be charged as soon as possible.

FREEWHEEL MODE

Your power wheelchair is equipped with two freewheel levers. These levers allow you to disengage the drive motors and maneuver the chair manually.



Warning!

DO NOT use your wheelchair while the drive motors are disengaged unless someone is there to push you. The chair could roll on its own causing injury!

To engage or disengage the freewheel feature:

1. Turn the freewheel levers outward to disengage the drive motors.
2. Turn the freewheel levers inward, to engage the drive motors.



Caution

It is important to remember that when your power wheelchair is in freewheel mode, the braking system is disengaged.

SECURITY FUNCTIONS

1. The forward/backward/turn speed, acceleration and deceleration are programmable.
2. Thermal overload protection.
3. Current overload protection.
4. The fault diagnostics of the controller (see “Troubleshooting” section).
5. The power-chair will not operate while charging the batteries.

TRANSPORTING YOUR CHAIR

If you will be traveling with your power chair, you may find it necessary to use a lift/elevation product or portable ramp to aid in transportation. ActiveCare suggests you closely review the instructions, specifications, and safety information included with the lift/elevation product before using that product.



Warning!

Never sit on your power chair when it is being used in connection with any type of lift/elevation product or portable ramp. Your power chair was not designed with such use in mind and any damage or injury incurred from such use is not the responsibility of ActiveCare.

ActiveCare recommends that you do not remain seated in your power chair while traveling in a motor vehicle. The power chair should be stowed in the trunk of a car or in the back of a truck or van with batteries removed and properly secured.

 **Warning!**

Always be sure your power chair and its batteries are properly secured when it is being transported. Batteries should be secured in an upright position and protective caps should be installed on the battery terminals. Batteries should not be transported with any flammable or combustible items.

 **Warning!**

Do not sit on your power chair while it is in a moving vehicle.

POSITIONING BELTS

Your authorized ActiveCare Provider, therapist(s), and other healthcare professionals are responsible for determining your requirement for a positioning belt in order to operate your power chair safely.

 **Warning!**

If you require a positioning belt to safely operate your power chair, make sure it is fastened securely in order to reduce the possibility of a fall from your power chair.

 **Warning!**

The positioning belt is not designed for use as a seat belt in a motor vehicle. Nor is your power chair suitable for use as a seat in any vehicle. Anyone traveling in a vehicle should be properly belted into seats approved by the vehicle manufacturer.

USE ON INCLINES

Many buildings have wheelchair-accessible ramps with specified degrees of incline, designed for easy and safe access. Some ramps may have turning switchbacks (180-degree turns) that require you to have good cornering skills on your power chair. Proceed with extreme caution as you approach the downgrade of a ramp or other incline. **DO NOT** use on inclines greater than 6°. Take wide swings with your power chair's front wheels around any tight corners. If you do that, the power chair's rear wheels will follow a wide arc, not cut the corner short, and not bump into or get hung up on any railing corners.

When driving down a ramp, keep the power chair's speed adjustment set to the slowest speed setting to ensure a safely controlled descent. Avoid sudden stops and starts. When climbing an incline, try to keep your power chair moving. If you must stop, start up again slowly and then accelerate cautiously. When driving down an incline, set your power chair to the slowest speed setting and drive in the forward direction only. If your power chair starts to move down the incline faster than you anticipated or desired, allow it to come to a complete stop by releasing the joystick, then push the joystick forward slightly to ensure a safely controlled descent.

 **Warning!**

When on any sort of an incline or decline, never place the power chair in freewheel mode while seated on it or standing next to it.

⊘ Warning!

When climbing an incline, do not zigzag or drive at an angle up the face of the incline. Drive your power chair straight up the incline. This greatly reduces the possibility of a tip or a fall. Always exercise extreme caution when negotiating an incline.

⊘ Warning!

You should not travel up or down a potentially hazardous incline (i.e., areas covered with snow, ice, cut grass, or wet leaves).

⊘ Warning!

If your power chair is equipped with a reclining seatback, do not attempt to negotiate inclines with the seat in a reclined position. Do not attempt to negotiate obstacles with the seat in a reclined position unless an attendant is present to help stabilize the chair. Failure to heed could result in the power chair tipping over.

⊘ Warning!

Never travel down an incline backward. Doing so may cause the power chair to tip. Always exercise extreme caution when negotiating an incline.

Excessively high cornering speeds can create the possibility of tipping. Factors which affect the possibility of tipping include, but are not limited to: cornering speed, steering angle (how sharply you are turning), uneven road surfaces, inclined road surfaces, riding from an area of low traction to an area of high traction (such as passing from a grassy area to a paved area – especially at high speed while turning), and abrupt directional changes. High cornering speeds are not recommended. If you feel that you may tip over in a corner, reduce your speed and steering angle (i.e., lessen the sharpness of the turn) to prevent your power chair from tipping.

⊘ Warning!

When cornering sharply, reduce your speed and maintain a stable center of gravity. This greatly reduces the possibility of a tip or fall.

BATTERIES

Please charge the batteries after long distance driving to prolong the battery. If you don't drive the chair for along period of time, then charge at least every month. Please use a maintenance/water-free battery to avoid trouble.

MOTOR

The carbon brush connector & brakes should be replaced regularly.

ELECTRICAL BRAKES

Testing of the electrical brakes should be carried out on a level floor with at least three feet of clearance space around the power chair.

Power-on the controller, and push the joystick forward slowly until you hear the electrical brake working. The power wheelchair may start to move. Immediately release the joystick, you must be able to hear each electrical brake within a few seconds. Repeat the test three times, pushing the joystick backward, left and right respectively.

TIRES

Check front/rear tires regularly and replace them when worn out.



Suggestion

Tire wear is not covered under your power wheelchair's warranty.

TROUBLESHOOTING

The diagnostic flash codes for your power wheelchair are designed to help you perform basic troubleshooting quickly and easily. A diagnostic flash code flashes from all 6 of the LED's located on the controller in the event one of the conditions listed below develops.

Flash Code	Description	Recommended Action
1	Motor Current Over Limit	Motor current is over the controller set limit. Release the joystick to neutral and try again
2	Battery	Try charging the batteries. Batteries need replacing. Check the battery cables and connections
3	Left Motor	Check left motor cables and connections
4	Right Motor	Check right motor cables and connections
5	Left Parking Brake	Check left parking brake cables and connections
6	Right Parking Brake	Check right parking brake cables and connections
7	User Interface	Display PCB fault. Consult a service agent.
8	Controller	Consult a service agent.
9	A-series Bus Communication	Consult a service agent.

If more than one fault exists, the fault having the highest priority (and lowest number of flashes) is indicated. All faults disable the controller and require the controller to be turned off then on again once the source of the fault is removed.

Batteries & Charging

Before using your power mobility product for the first time, you will need to charge your batteries for 8 – 10 hours to ensure that they are fully charged.

i Suggestion

ActiveCare Medical recommends that frequent users of their power mobility products charge their batteries overnight, 8 – 10 hours, to make certain they have a full charge each day.

i Suggestion

ActiveCare Medical recommends that infrequent users of their power mobility product charge their batteries once a week for 8 – 10 hours.

ActiveCare Medical's battery chargers, specific to our product, are designed to not overcharge the batteries. You may leave your power mobility product plugged into the charger for longer than 8 – 10 hours without causing damage to the batteries.

In some instances ActiveCare Medical's battery charger may show two green lights indicating that the batteries are fully charged—this is not always the case. A good rule of thumb is to charge your batteries 8 – 10 hours before each use to ensure that your power mobility product has a full charge.

CHARGER FEATURES

1. Ensures the battery connection automatically.
2. Monitoring all procedures until the battery is fully charged.
3. For protecting exhausted batteries, slow charge starts in the beginning then fast charge until it goes up to the normal voltage.
4. Compact, portable and light-weight.
5. Approvals: UL, CSA, CE, TUV, JAPAN (T-mark)

OPERATION INSTRUCTIONS

Please follow these steps:

1. Select the correct input voltage (115/230V) on the 115/230V option switch.
2. Assure charging on lead-acid batteries only.
3. Keep the AC power switch off until the battery and charger have been connected.
4. Make sure the output end of the charger corresponds with the positive/negative pole of battery.
5. Turn on the AC power switch to "I" (the fan should begin to run).

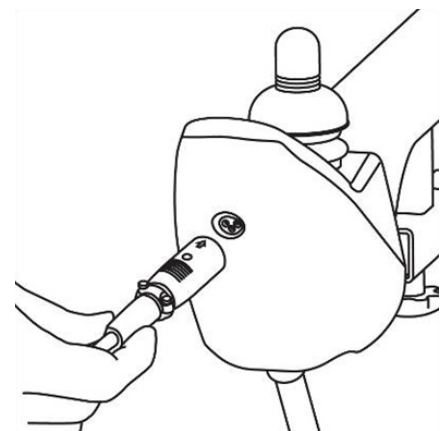

When LED turns to red/yellow, it means the charger has been under normal charging condition.

6. When LED turns to red/green, it means the battery has been fully charged. The charging procedure has completed.
7. While the yellow/green LED is lit, it may have a temporary alternating occurrence around 1-60 seconds during switching. Please note that this is normal.

USAGE ENVIRONMENT

1. Please keep the charger at least 2 inches away from other objects when charging.
2. Do not use it on wet and dirty surfaces.
3. Do not place the charger on the battery.

NOTES

1. Ensure the output-DC voltage corresponds to the battery type and voltage. Otherwise it may cause an explosion.
2. Switch off the charger before connecting the charger and the battery.
3. Do not expose the charger to the rain, water or near flammable materials. Do not store the charger in humid places or in a closed area.
4. The warranty is given for use within normal operating conditions; it does not cover accidental damage, or problem caused by user's neglect or misuse.

Specifications

Max. Weight Capacity	450 lbs.	
Maximum Speed	4 mph	
Estimated Range	15 miles	
Maximum Grade/Incline	6°	
Turning Radius	31"	
Ground Clearance	3"	
Overall Dimensions		
Length	40"	
Width	24.5"	
Height	42"	
Seat Dimensions		
Width	22"	24"
Depth	18"	20"
Back	20"	
Armrest to Seat	7"	
Power		
Motor	Two 24V x 500W x 4600rpm	
Controller	Dynamic Shark 60	
Batteries	Two DC12V x 50AH	
Battery Charger	5 Amp, Offboard	
Brakes		
Electromagnetic		
Freewheel Mode	Yes	
Tires		
Front Casters:	8.5" x 2.5" (solid)	
Rear Drive Wheels:	14" x 3" (Foam-Filled)	
Weights		
Weight without Batteries	143 lbs.	
Weight with Batteries	224 lbs.	

User's weight, road conditions, battery charge, etc. will influence performance.

ActiveCare reserves the right to modify the specifications if necessary. The final specifications are subject to the individual power wheelchair your purchase from your dealer.

Limited Warranty

For the periods listed below, beginning at the date of purchase, ActiveCare Medical will repair or replace, at our option to the original purchaser, free of charge, any of the following parts found upon examination by an authorized representative of ActiveCare medical to be defective in materials and/or workmanship.

Sixty (60) Month Limited Warranty

Main frame assemblies, including:

- Main frame
- Seat post
- Wheel forks
- Springs and suspension

Thirty-Six (36) Month Limited Warranty

- Metal seat brace, bracket and bracket lever

Thirteen (13) Month Limited Warranty

Electronic components, including:

- Charger assembly
- Controller
- Joystick
- PC board
- Throttle

Other components, including:

- Brakes (electronic function ONLY)
- Bearings and bushings
- Electrical harness
- Motor/gearbox assembly
- Plastic components, excluding body
- Front rigging mounting brackets

Six (6) Month Limited Warranty

- Batteries (*ActiveCare Medical will only replace batteries once within the 6 month warranty period.*)

Additional Components

Items not mentioned or listed are covered at the discretion of ActiveCare Medical. Any accessories, standard or optional, supplied by ActiveCare Medical, are covered for a period of one year from the date of purchase with the particular unit.

- Plastic shrouds and footrests
- Motor brushes
- Upholstery and Seating
- Armrest Pads
- Brake pads
- Fuses/Bulbs
- Tires and tubes
- Anti-tip wheels
- Floor mats
- Metal connection pins,
- Swing arm hardware, nuts, bolts & star knobs
- Plastic connections

Reconditioned Units Warranty

All reconditioned units are covered by a 90-day warranty from ActiveCare Medical effective from the date of purchase.

Warranty Exclusions

Full product warranty is extended to the original purchaser for new consumer purchases only. This warranty is not extended to third-party payers or renters for whom a separate rental agreement exists. Please contact your authorized ActiveCare Medical provider for further information on rental product warranty.

ActiveCare Medical does not provide warranty on any of the following items which may require replacement due to the normal wear and tear of day-to-day usage.

If the following items are found to be defective or damaged immediately after the product is removed from the box, ActiveCare Medical will repair or replace, at our option to the original purchaser, free of charge, these items within 30 days of the product being removed from the box.

Exclusions also include components with damage caused by:

- Contamination
- Abuse, misuse, accident or negligence
- Excessive wear
- Battery fluid spillage or leakage
- Commercial use, or use other than normal
- Improper operation, maintenance or storage
- Exceeding the specified weight capacity of the unit
- Acts of Nature, such as lightning strike, earthquake, etc.
- Accessories other than those supplied or approved by ActiveCare Medical
- Circumstances beyond the control of ActiveCare Medical including, but not limited to, seat flattening, burn holes, split seams, cracking or lost hardware.
- Labor, service calls, shipping and other charges incurred for repair of the product, unless specifically authorized by ActiveCare Medical, Inc.
- Repairs and/or modifications made to any part without specific consent from ActiveCare Medical.

NOTE: Gradual deterioration in performance because the battery has been left in the discharged state, left in cold conditions for an extended period of time, or work out through heavy use is not covered.

Service Checks and Warranty Service

Warranty service must be performed by an authorized ActiveCare Medical provider. Do not

return faulty parts to ActiveCare Medical without prior written authorization. All transportation costs and shipping damage incurred while submitting parts for repair or replacement are the responsibility of the purchaser.

Failure to follow the instructions, warnings and notes in the owner's manual and those located on your ActiveCare Medical product can result in personal injury or product damage and will void ActiveCare Medical's product warranty.

There is no other express warranty.

Implied Warranties

Implied warranties, including those of merchantability and fitness for a particular purpose, are limited to one (1) year from the date of purchase and to the extent permitted by law. Any and all other implied warranties are excluded. This is the exclusive remedy. Liabilities for consequential damages under any and all warranties are excluded.

Some states do not allow limitations on how long an implied warranty lasts or do not allow the exclusion or limitation of incidental or consequential damages. The above limitation or exclusion may not apply to you.

This warranty gives you specific rights and you may also have other rights which vary from state to state.

Please fill out and return the product registration card to ActiveCare Medical. This will aid ActiveCare Medical in providing the best possible technical and customer service.

Product Registration



Thank you for purchasing an ActiveCare power mobility product!

Your ActiveCare product will provide you years of dependable service and mobility ease. To validate your product's warranty, you must complete this form and return it to ActiveCare Medical immediately.

Please print or type.

Your Name

Your Address

City

State

Zip

Phone Number

E-mail Address

() -

Product Information

Model

Date Purchased

/ /

Month

Day

Year

Serial Number

Dealer Purchased From

Dealer Address

City

State

Zip

Phone Number

() -

Place
Stamp
Here

ActiveCare Medical Product Registration

2 Harbison Way

Columbia, SC 29212

Fold Here----- Fold Here ----- Fold Here