

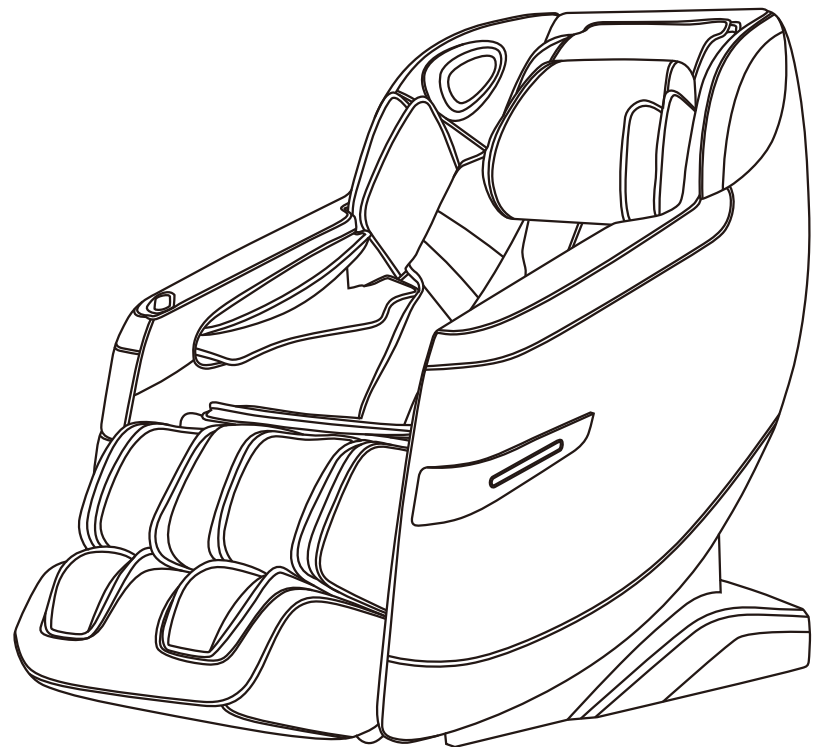

Titan 3D Quantum MASSAGE CHAIR

OPERATION INSTRUCTIONS

SAVE THESE INSTRUCTIONS



1. Thank you for purchasing this product. Please read this manual instructio carefully in order to know how to use this product correctly before operation.

Please pay more attention to the important safety warnings and keep this manual for future use.

2. Table of Contents

Product Specifications should line up with the previous Table of Contents listed.

TABLE OF CONTENTS

Safety and Maintenance	02-03
Safety Warning	04-07
Name of Components	08
Function	09
Introduction to the Remote Controller	10-11
Method of Usage	12-30
I. Turn on the power supply of this product	12
II. Massage Function Control Operation	12-30
III. Voice Control Mode	30
IV. End massage	31
V. Operation Instructions for Bluetooth Speaker Play	32
VI. Instructions for installation of lower leg	32
VII. Instructions for Removal and Use of Head Cushion and Backrest	33
VIII. Floor Protection	34
IX. Instruction for Movement	34
Product Specification	35

Safety and Maintenance

1. Important Safety Warnings

- Do not allow children to touch any movable part of this product.
- Use the well-grounded power supply unit suitable for this product.
- Pull out the plug after use or before cleaning to avoid any physical injury or damage to the product.
- Operate this product as instructed in this manual.
- Do not use any parts or accessories which are not recommended.
- Do not use this product outdoors.
- Please read the Operation Instructions carefully before operation.
- Never use this product for any other purpose not listed herein.
- 20 minutes of usage each time is recommended.
- Do not use this product if the leather is broken or damaged.
- Do not use this product if the cover or leather is broken or damaged.
- Do not use this product if the radiator hole is covered or blocked.
- Do not drop anything into this product.
- Never fall asleep while using this product.
- Do not use this product if you are drunk or feel unwell.
- Do not use this product within one hour after a meal.
- Do not use this product with excessive force to avoid any injury.
- Do not carry any fragile, explosive, or combustible material in your pocket, such as a mobile phone and lighter when using the massage chair.

2. Operating Environment

- Do not use this product in a very moist environment such as the bathroom.
- Stop using this product immediately when the ambient temperature changes sharply.
- Do not use this product in any heavily-dusty or caustic environment.
- Do not use this product in a small space or a place without good ventilation.
- The normal room temperature ranges from 0 °C to 35 °C.
- Do not use this product in an excessively humid room such as a bathroom. Use it at a relative humidity between 20% and 80%.
- Do not use this product outdoors.
- Avoid direct sunlight.
- Keep this product away from any heat source such as a stove and air outlet of an air conditioner.
- Do not use this product during thunder or lightning weather.
- Do not use this product in dusty places.

3. The following populations should not use this product:

- Patients with osteoporosis.
- Patients with heart disease or wearing electronic medical devices such as a pacemaker.
- People who have a fever.
- Pregnant women or women on their menstrual period.
- Patients who are injured or have a skin disease.
- When unsupervised, any children are under the age of 14 and those unconscious are not allowed to use this product.
- People who are told by their physicians to have rest or who feel unwell.
- People whose bodies are wet are forbidden to use this product.
- This product has a hot surface. Persons insensitive to heat must pay attention when using this product.

Safety and Maintenance

4. Safety Precautions

- Check whether voltage is consistent with the specification of this product.
- Never insert or pull out the plug with a wet hand.
- Do not let water flow into this product to avoid electric shock or cause damage to this product.
- Do not pull the power cord when plugging or unplugging it. Rough handling is forbidden.
- Do not damage the wire or modify the circuit of this product.
- Do not clean live parts of this product with a wet cloth such as a power switch and plug.
- Be away from this product in case of power failure to avoid any injury if power is restored suddenly.
- Stop using this product at once while it works abnormal, and consult your local supplier.
- Stop using this product if you feel unwell, and consult your health care practitioner.
- This product is not intended for use by persons (including children) with reduced physical, sensory or mental capabilities, or lack of experience and knowledge, unless they have been given supervision or instruction concerning the use of this product by the personnel responsible for their safety. Children should be supervised to ensure that they do not play with this product.
- If the power cord is damaged, it must be replaced by the manufacturer, its service agent or similarly qualified staff in order to avoid hazards.

5. Product Service and Maintenance

- This product should be maintained by the service center designated by the manufacturer only. No user should disassemble or maintain it without permission.
- Do not forget to turn off the main power switch after usage.
- Do not use this product if the power socket becomes loose.
- If this product will be left unused for a long period of time, it is necessary to roll up the power cord of this product and store this product in a dry and dust-free environment.
- Do not store this product at a high temperature or near open flame. Avoid prolonged exposure to direct sunshine.
- Please clean this product with dry cloth. Never use thinner, benzene or alcohol.
- The mechanical components of this product are specially designed and manufactured, so no special maintenance is needed.
- Do not use a sharp object to stab at this product.
- Do not roll or pull this product on any uneven ground. Instead, it should be lifted before moving.
- Please use this product intermittently. Do not keep it working continuously for a long period of time.

6. Solutions to Ordinary Malfunctions

- If the motor sounds during operation of this product, this is the normal operation sound.
- If the controller cannot work normally, check whether the plug and the power socket are connected reliably, and whether the power switch is turned on.
- If the rated working time is over, this product will automatically activate the power-off button; If this product keeps operating for a long period of time, the temperature protector will stop this product automatically. The product can be used again after half an hour.

7. Storage Conditions

- Storage room temperature: -5 °C to 35 °C.
- Relative humidity (RH) between 20% and 80%; free of corrosive gases, and a well-ventilated room.

Safety Warning

! Warning

When the legrest of the massage chair is lifted, nobody should apply pressure on the legrest to prevent the massage chair from falling forward which will damage this product or result in personal injuries.

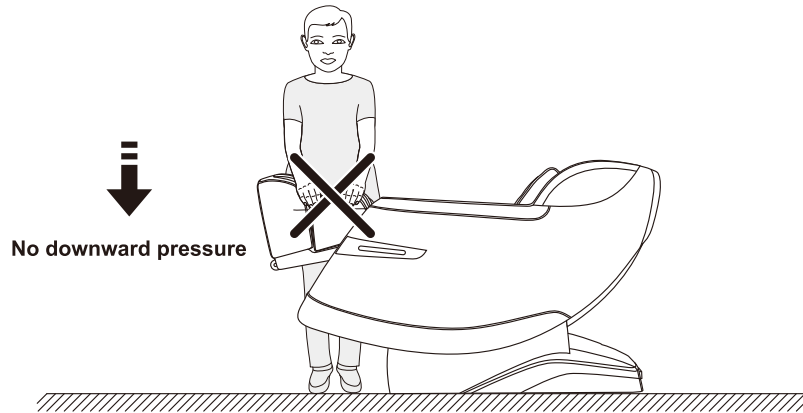

! Warning

Before sitting on the massage chair, make sure that the massage chair manipulator does not stay in the seat cushion position to avoid discomfort to the buttocks during the body pressing down and any damage to the massage chair manipulator.



Safety Warning

! Warning

Do not remove or pull out the remote controller cable or the power cord in the standby or power-on state to avoid any damage to this product or accidental electric shock of a body part. You are advised to unplug the remote controller cable and the power cord and put them away after you use the massage chair.

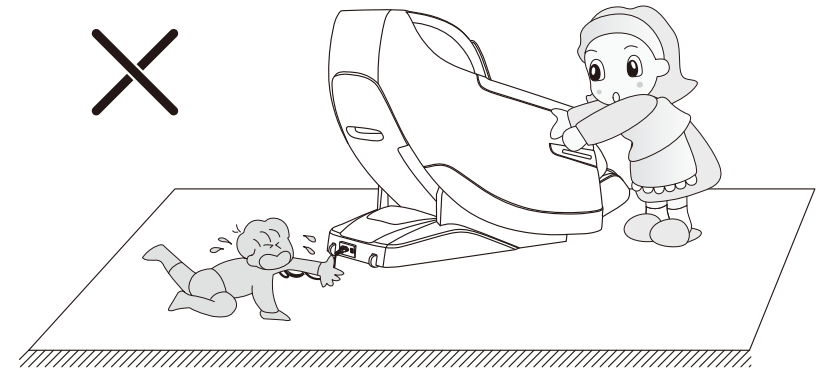

! Warning

When the zero-gravity lying function is enabled, be sure to check whether there is any child or pet staying or playing under the bottom of the legrest and backrest, in order to avoid any damage to this product or physical injury.

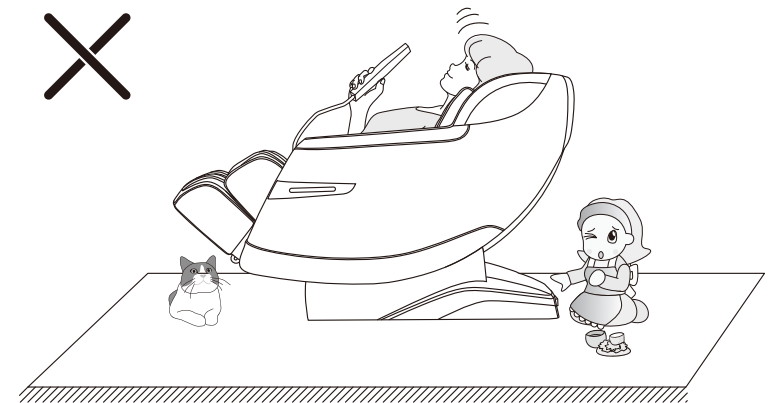

Safety Warning

⚠ Warning

Before using the massage chair, remove any hard objects in your pocket(s) or any jewelry carried with you (e.g. key, watch, other similar portable hard objects) to avoid any damage to this product or physical injury during massage.

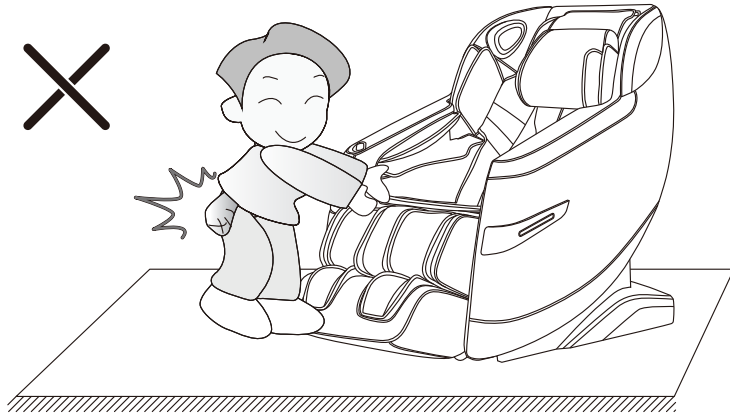

⚠ Warning

Do not unplug the power cord, or directly turn off the power switch on the back of the massage chair during massage, in order to avoid any damage to this product or physical injury.

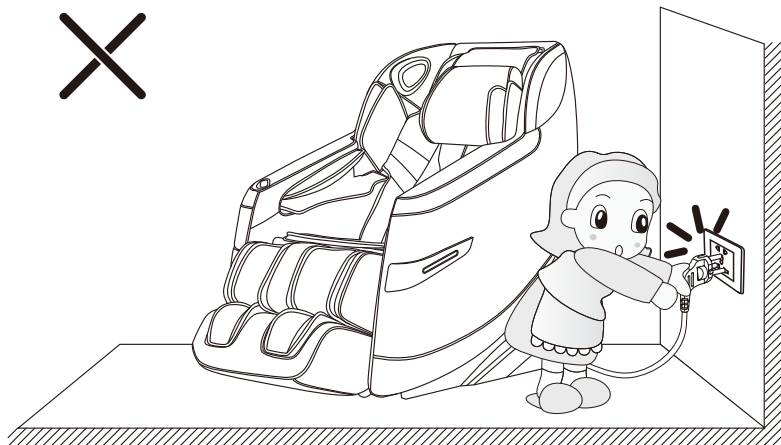

Safety Warning

⚠ Warning

Please do not fall asleep on the massage chair while using to avoid personal injury caused by unconscious use.

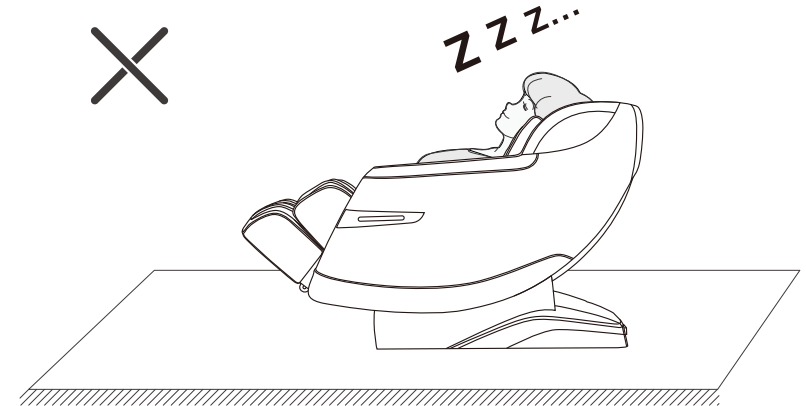

⚠ Warning

The massage chair should not be used by more than one person at a time to avoid product failure or personal injury. In addition, do not let children play on the massage chair or climb onto the lower leg, seat cushion, foot, backrest or armrest. Otherwise, accidents or injuries may be caused.

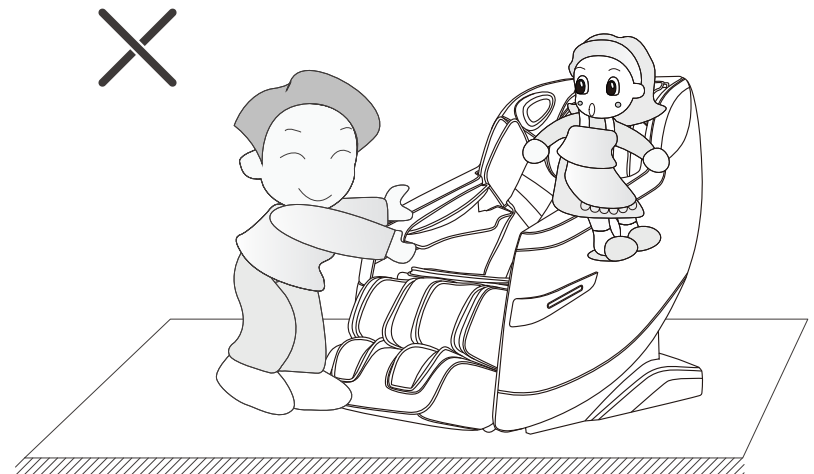

Name of Components

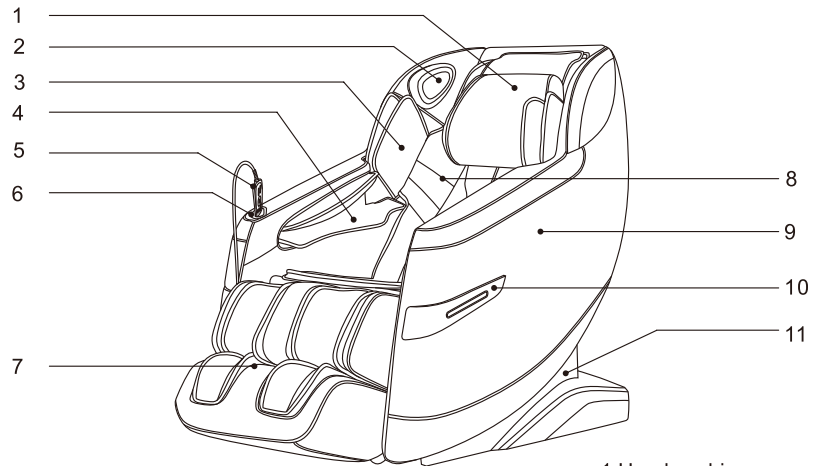

- 1.Head cushion
- 2.3D digital audio (built-in voice control microphone)
- 3.Upper arm airbag component

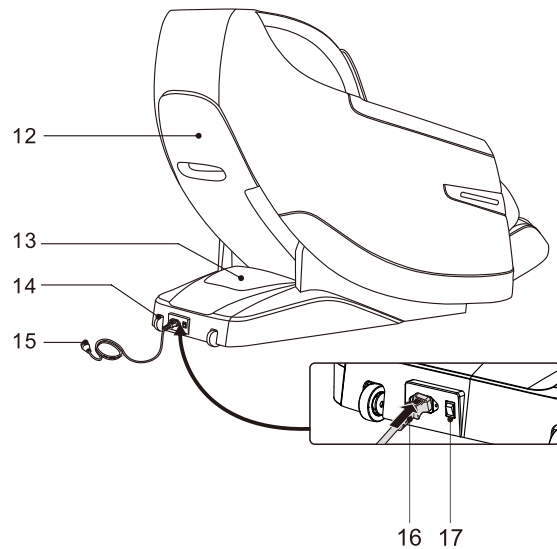

- 4.Arm airbag component
- 5.Controller
- 6.Controller placement slot
- 7.Lower leg frame
- 8.Backrest cushion
- 9.Armrest
- 10.Armrest decoration
- 11.Side cover
- 12.Backrest cover
- 13.Rear cover of power box
- 14.Movable pulley
- 15.Power cord and plug
- 16.Mains input
- 17.Switch

Function

- This product has designed a group of AI intelligent core massage manipulators that can walk up and down, stretch back and forth, and are silent in design.
- It is designed with the function of automatic detection and micro-adjustment of shoulder position and the automatic detection function of human body curve and massage finger pressing point to automatically adjust the stretch back and forth of the manipulator according to the detected human body curve and massage finger pressing point, making massage more humanized and scientific.
- With characteristic automatic massage function: Comfort massage, Relaxing massage, Stretch Massage, Neck&shoulder Massage, Back&Waist Massage, Full body Massage, Ancient Beauty Care, Leg&hip Care, Release Sedentary Stress, Spine Care, President Cosy, Relieve Soreness, Good-night Sleep, Sport Recovery, and Meridian Treatment 15 kinds of automatic massage functions.
- It has three intelligent storage functions: storage I, storage II and storage III.
- It is provided with five message scopes for manual selection, i.e. fixed point, upper back, lower back, local and whole body.
- It is provided with manual massage function: including eight massage methods such as stopping, kneading, slapping, kneading and slapping, finger pressing, tapping and 3D (3D I and 3D II).
- It is provided with massage adjustment function: including 3D intensity 3-gear adjustment, air compression intensity 3-gear adjustment and time adjustment 4-gear adjustment.
- It is provided with an upper body air compression massage function: palm air compression massage function (built-in 4 airbags), shoulder air compression massage function (built-in 2 airbags), arm air compression massage function (built-in 4 airbags), and 3-gear air compression intensity adjustment.
- It is provided with a lower body air compression massage function: lower leg air compression massage function (built-in 12 airbags) and 3-gear air compression intensity adjustment.
- Slide rail technology is adopted for lying down of the backrest frame to make the backrest 8cm from the wall, thus saving space to the greatest extent.
- The guide rail of the backrest frame adopts curved guide rail technology, which completely conforms to the back of the human body and makes people enjoy a massage from the head to the thigh.
- It is provided with an intelligent voice control recognition function.
- Music playing system, with built-in 3D digital audio in the left and right upper arms. The Bluetooth function of intelligent devices can be used for wireless connection to play music.
- It is provided with leg traction massage function: the lower leg and backrest are lifted to form automatic lying down in a cyclic manner. At the same time, the lower leg air compression and the back manipulators cooperate together to massage, and the legs can be stretched for traction massage.
- It is provided with a separate lifting adjustment function for the lower leg frame, linkage lifting adjustment function for the backrest frame, and zero-gravity automatic lying angle adjustment function.
- It is provided with a foot and sole roller massage function. Three groups of rollers roll to scrape and massage toes and roots of feet, and roll to scrape and massage the arch of feet. The speed is adjustable in three gears.
- The lower leg frame is provided with a spring retractable adjustment function. The length for the user to stretch out his/her feet is dependent on his/her feet, and the user stretches back his/her feet by spring force.
- With bumps and magnet therapy massage functions in palm massage area
- Automatic sit-up function when the power is off and manipulator automatic reset function.
- With back heating and leg heating functions: Carbon fiber as far infrared heat source.
- Equipped with TFT color screen manual controller.

Introduction to the Remote Controller

Display screen section of manual controller

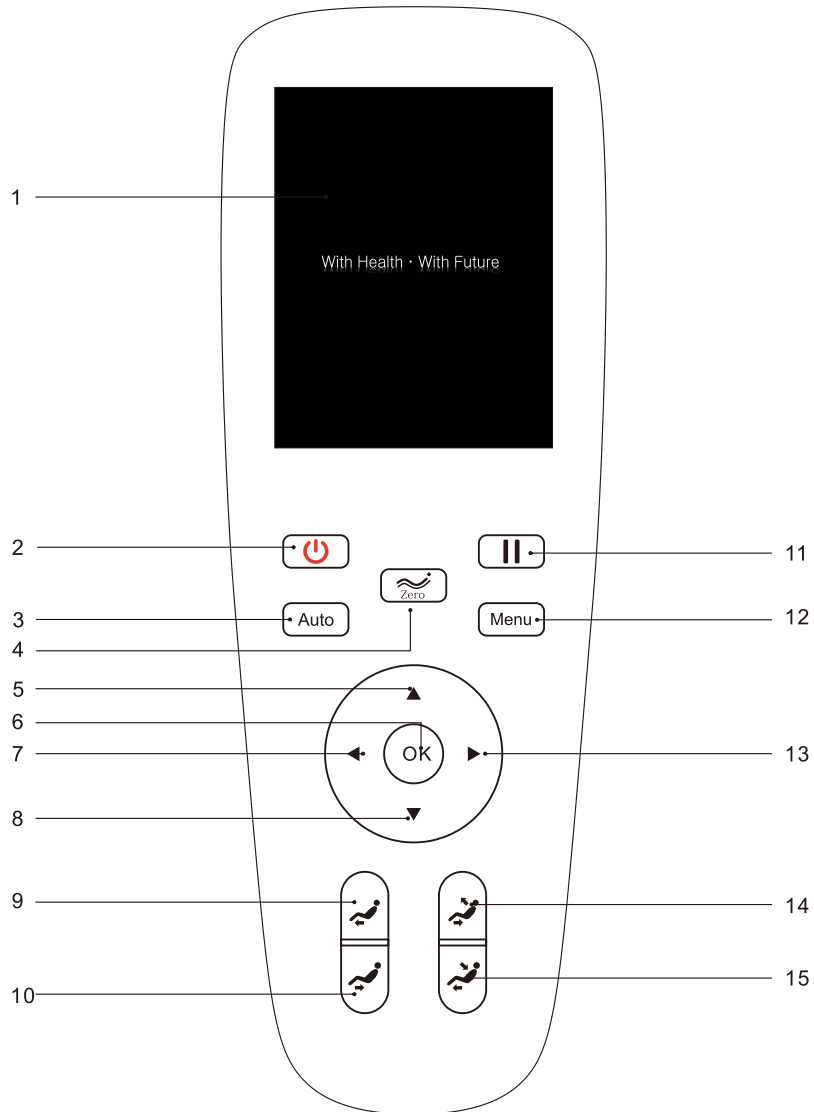

Introduction to the Remote Controller

1. Display screen:
 - TFT color liquid crystal display screen displays the massage function in the running state.
2. On/off key:
 - Turn on or off the massage chair.
3. Automatic key:
 - Enter the automatic function mode selection interface. Please refer to page 15 of this manual for detailed function description.
4. Zero-gravity key:
 - Adjust the zero-gravity angle of the massage chair, and there are four modes for selection (pressing for the first time enters the first gear, pressing for the second time enters the second gear, pressing for the third time enters the third gear, and pressing for the fourth time restores to the initial state).
5. Up key:
 - Navigate the Up key, select the object upward in the menu, or adjust the massage position upward.
6. OK key:
 - Confirm the selected massage function to perform confirmed massage.
7. Left key:
 - Navigate the Left key, return to the previous menu, or select the object to the left.
8. Down key:
 - Navigate the Down key, select the object downward in the menu, or adjust the massage position downward.
9. Lower leg frame ascending key:
 - According to the user's own massage requirement, the lower leg frame is ascended to the most comfortable massage posture.
10. Lower leg frame descending key:
 - According to the user's own massage requirement, the lower leg frame is descended to the most comfortable massage posture.
11. Pause key:
 - Pause all currently running massage functions, and press this key again to continue running all massage functions before the pause.
12. Menu key:
 - Enter the main menu selection interface. Please refer to page 15 of this manual for detailed function descriptions
13. Right key:
 - Navigate the Right key to enter the sub-menu, or select the object to the right.
14. Linkage sit-up key:
 - According to the desired massage angle, the backrest frame and the lower leg frame are adjusted for linkage sit-up at the same time to the most comfortable linkage sit-up massage posture.
15. Linkage lying key:
 - According to the desired massage angle, the backrest frame and the lower leg frame are adjusted for linkage lying at the same time to the most comfortable linkage lying massage posture.

Method of Usage

I. Turn on the power supply of this product:

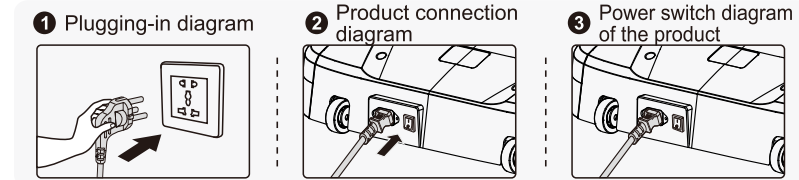

II. Massage Function Control Operation:

1. Standby

- After the massage chair is powered on and off, the manual controller has a black screen and cannot perform any operation (except the on/off key) in the standby state.

2. Start massage (on/off key)

- Press the on/off key to start the massage, and the backrest frame and lower leg frame will automatically lie down to the set angle.
- After lying in place automatically, the massage chair automatically detects the shoulder position and body shape waiting for the detection to be completed. Or press the "OK" key to directly skip the shoulder position and body shape detection, then turn on the default value to start massage.

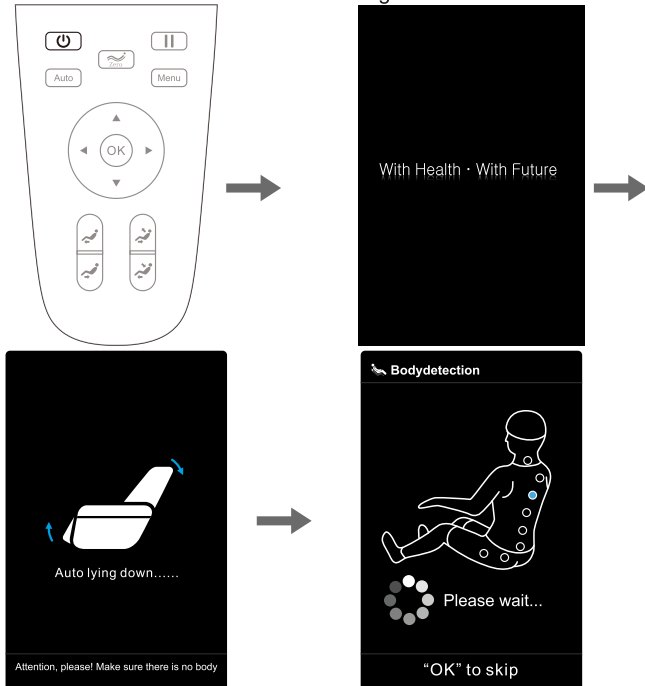

Method of Usage

1). Shoulder position adjustment

- After detecting the shoulder position, the buzzer prompts with a "beep." If there is any difference from the actual shoulder position, adjust to the appropriate position by pressing "Up" or "Down." Shoulder position is adjustable in 11 gears. If there is no shoulder position adjustment within 10 seconds, it will automatically enter the massage function. If you press the "OK" key directly, you will enter the massage immediately. If the shoulder position cannot be detected, massage is performed at the default shoulder position height.

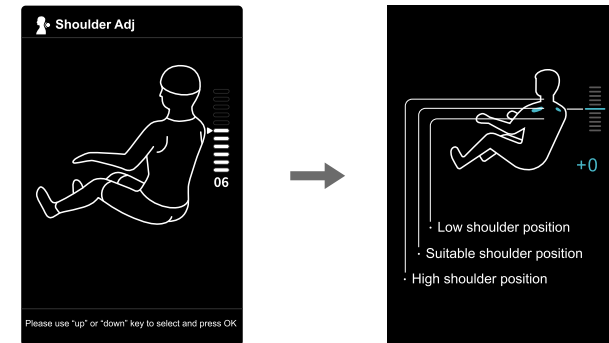

Button	Description
	Move the massage balls upward to a suitable shoulder position
	Move the massage balls downward to a suitable shoulder position

- After entering the massage program, if it is necessary to adjust the shoulder, from the operation status information interface, you can directly select the shoulder adjustment button to enter the whole shoulder adjustment interface, and adjust the shoulder position and height through the "Up" or "Down" key; press the "Left" key to return to the previous menu interface.

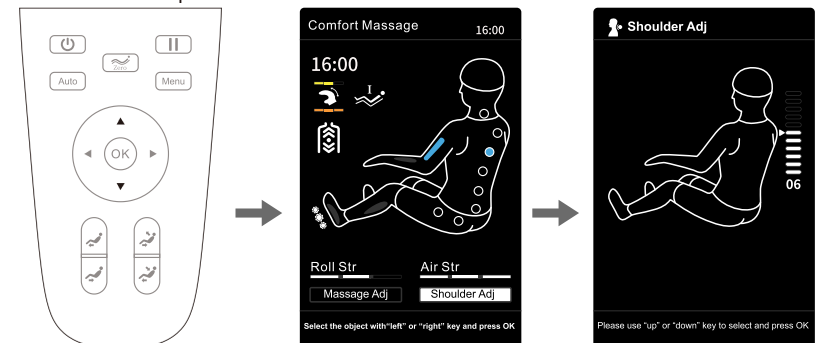

Method of Usage

2). Message position adjustment

- After entering the message program, if it is necessary to adjust the message position, press the "Menu" key on the manual controller to select the manual program to enter, select the manual program, and then press the "Left" key to return to the information interface (the information interface is changed to the manual program interface).
- From the manual program interface, if the message position displays fixed points or local, you can directly press the "Up" or "Down" key to move the manipulator up and down.
- From the manual program interface, if the message position is not fixed point or local, you need to select message adjustment to enter, then select the message part, select fixed point or local, then press the "Left" key to return to the information interface, and then press the "Up" or "Down" key to move and adjust the manipulator up and down.

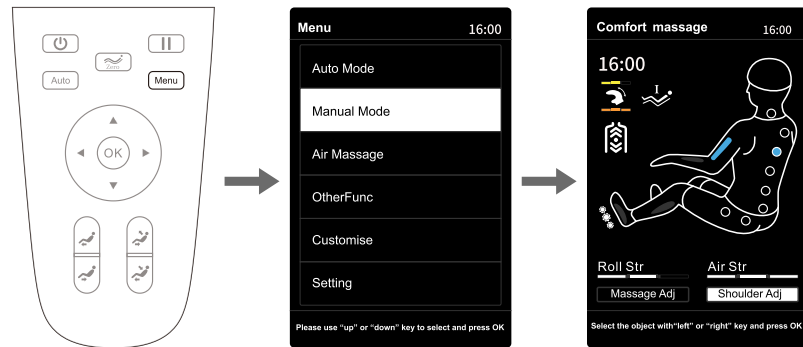

Note: If you select message adjustment in the automatic function interface, you cannot perform the massage scope adjustment.

3.Pause key

- When the massage function is running, press the "Pause" key to temporarily stop all massage functions; press the "Pause" key again to continue the massage function before the pause. If the pause lasts for more than 20 minutes, all massage functions will be automatically turned off.

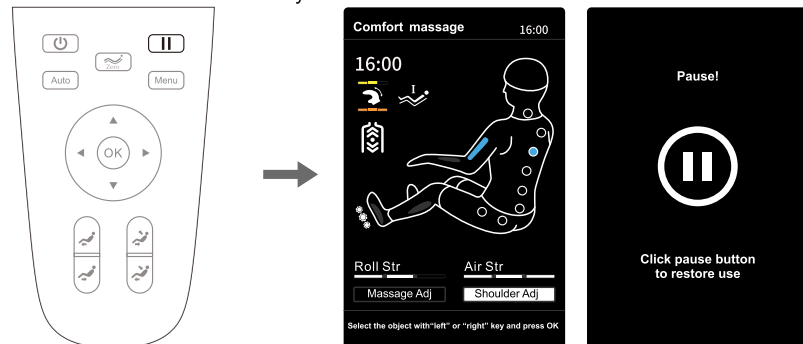

Method of Usage

4.Menu key

- Press the "Menu" key to enter the menu message function selection interface, including automatic program, manual program, air compression massage, auxiliary function, memory storage, setting function, etc.
- After entering the menu interface, press the "Up" or "Down" key to select the desired message function, select any function, and then press the "OK" key to confirm. Press the "Left" key to return to the previous menu interface.

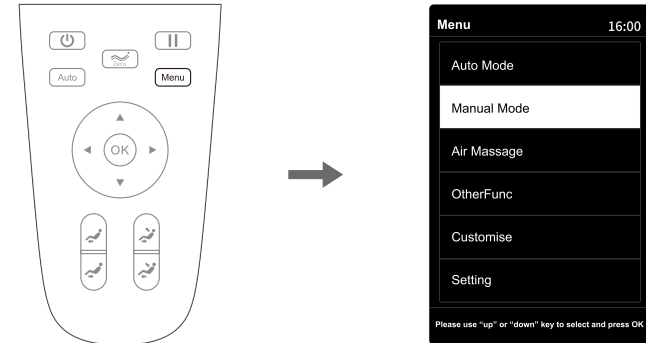

1).Automatic program (menu - automatic program, or you can also enter the automatic program interface through the "Automatic" key)

- Press the "Menu" key to enter the menu interface, press the "Up" or "Down" key to select the automatic function, and press the "OK" key (or directly press the "Automatic" key in the information interface) to enter the selection of the automatic function.
- Automatic functions include eight automatic massage modes, i.e. fast massage, comfortable massage, easy massage, whole body massage, shoulder and neck massage, back and waist massage, traction massage and exercise recovery.
- Enter the automatic function interface, press the "Up" or "Down" key to select any automatic function massage program, and then press the "OK" key to confirm. It will automatically return to the information interface, and the information interface will be displayed as an information interface with automatic functions.

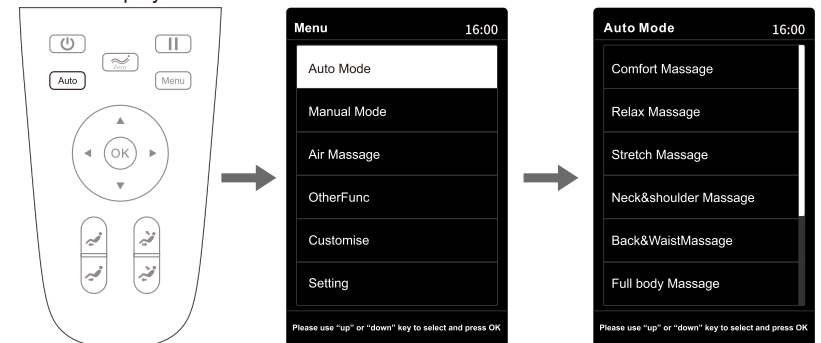

Method of Usage

Function	Description
Comfort Massage	The most comfortable massage experience.
Relaxing Massage	Gentle and comfortable deep massage, which can relieve body fatigue and relax the body.
Stretch Massage	The lower leg frame and the backrest frame are lifted and lowered for stretching and traction of the leg and waist, effectively relieving tiredness, relieving joint soreness and restoring vitality.
Neck&shoulder Massage	According to the unique neck and shoulder massage method, through effective massage of cervical spine and scapula, neck and shoulder pain can be relieved and neck and shoulder fatigue can be improved.
Back&Waist Massage	Focus on the back and waist to relieve back and waist soreness.
Full body massage	Deep massage, which can revive body vitality.
Ancient Beauty Care	The back and legs heating function started, massage manipulator combine with shoulder airbags, kneading massage focus on neck and shoulder, kneading and tapping massage on back and waist, kneading massage on buttocks, kneading and tapping massage on laps, foot rollers, legs airbags and arm airbags massage started at same time.
Leg& hip Care	The foot roller and legs heating function started, air bags inflate and deflate, and the massage manipulator move from legs to buttock with kneading and flapping massage technique.
Release Sedentary Stress	Aim to office sedentary group, increase the amount of physical exercise by massage, improve the body function.
Spine Care	Protect the health of the whole spine, and improve the lack of exercise.
President Cosy	The massage manipulator, combine with airbags, rollers, heating functions and the music played by bluetooth connecting, relax the physical and mental pressure of business groups.
Relieve Soreness	Soothe fatigue and pain on the human body, relax the limbs and improve micro-circulation, relieve joint pain and restore vitality.

Method of Usage

Good-night Sleep	With kneading, shiatsu massage techniques, combined with low-intensity air pressure massage and back heat therapy function, through the 12 health acupoints massage, help to regulate and balance on human body; At the same time, the massage chair automatically swings back and forth to form a zero-gravity cradle massage state, so that people can fall asleep more quickly, improve sleep quality.
Sport Recovery	By pressing and rubbing with the air bag and rolling with the wheel, it can relieve the swelling of the shoulders, arms, knees, calves and other key parts after exercise, and quickly recover the fatigue after exercise.
Meridian Treatment	Dredge the channels and collaterals, quickly improve the body's micro-circulation, and enhance immunity.

2). Manual program (menu - manual program)

- Press the "Menu" key to enter the menu interface, press the "Up" or "Down" key to select the manual program, and press the "OK" key to enter the manual function interface.
- Manual program: including method, position, width, speed and other massage functions.
- After entering the manual program interface, press the "Up" or "Down" key to select any manual program, then select the function sub-menu using the "Right" key, and then press the "OK" key to confirm. Press the "Left" key to return to the previous menu interface.

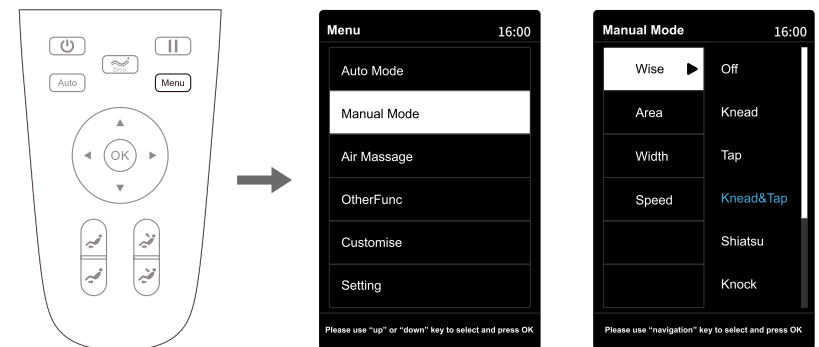

Method of Usage

01).Manual program - method

- Method: including 8 different massage methods such as stopping, kneading, tapping, kneading and Tapping, shiatsu, knocking and 3D (3D I and 3D II). The width of the manipulator massage ball can be adjusted under the massage methods including tapping, shiatsu, knocking and 3D II. Except for stopping, the massage speed can be adjusted under other massage methods.
- After entering the manual program interface, press the "Up" or "Down" key to select the message method function, enter the message method sub-menu using the "Right" key to select, then press the "Up" or "Down" key to select any message method, and press the "OK" key to confirm; press the "Left" key to return to the previous menu interface.

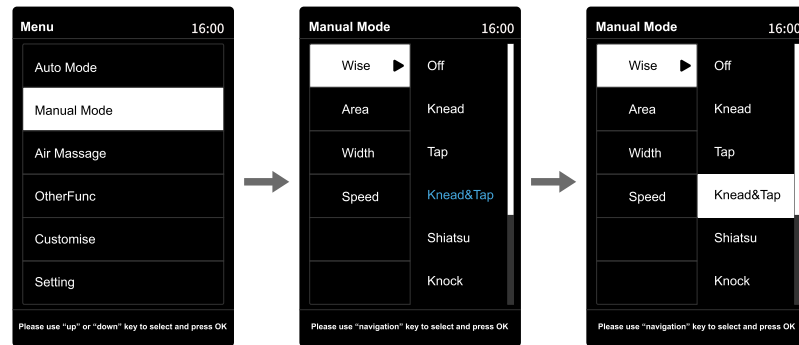

Function	Massage ball adjustment	
Stop	Width.	Adjustable speed in three gears Adjustable width in three gears
Kneading	Speed.	
Tapping	Speed and width.	
Kneading and Tapping	Speed	
Shiatsu	Speed and width.	
Knocking	Speed and width.	
3D I	Speed.	
3D II	Speed and width.	

Method of Usage

02).Manual program - position

- Position: including fixed point, local, upper body, lower body and whole body.
- After entering the manual program interface, press the "Up" or "Down" key to select the message position function, enter the message position function sub-menu using the "Right" key to select, then press the "Up" or "Down" key to select any message position, and press the "OK" key to confirm; press the "Left" key to return to the previous menu interface.

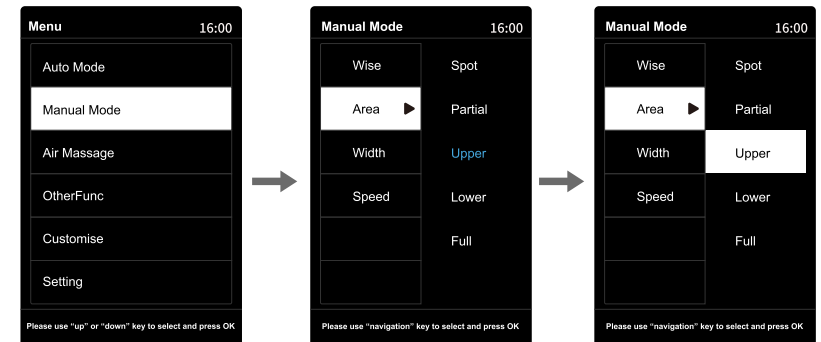

Function	Description	
Fixed point	Fixed-point massage at fixed-point position.	When selecting fixed-point and local massage methods, the massage area can be adjusted using the "Up" or "Down" key in the information interface.
Local	Small-scope local massage back and forth.	
Upper back	Upper back massage back and forth.	
Lower back	Lower back massage back and forth.	
Full back	Full back massage back and forth.	

Method of Usage

03).Manual program - width

- Width: Manipulator message width adjustment, with a total of 3 gears.
- Enter the manual program interface, press the "Up" or "Down" key to select the width function, enter the width function sub-menu using the "Right" key to select, then press "Up" key or "Down" key to select any message width, and press the "OK" key to confirm; press the "Left" key to return to the previous menu interface.

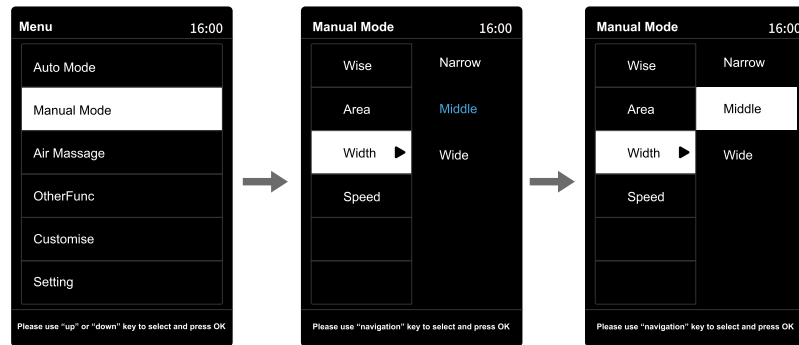

04).Manual program - speed

- Speed: Manipulator message speed adjustment, with a total of 3 gears.
- Enter the manual program interface, press the "Up" or "Down" key to select the speed, enter the speed function sub-menu using the "Right" key to select, then press the "Up" or "Down" key to select any message speed, and press the "OK" key to confirm. Press the "Left" key to return to the previous menu interface.

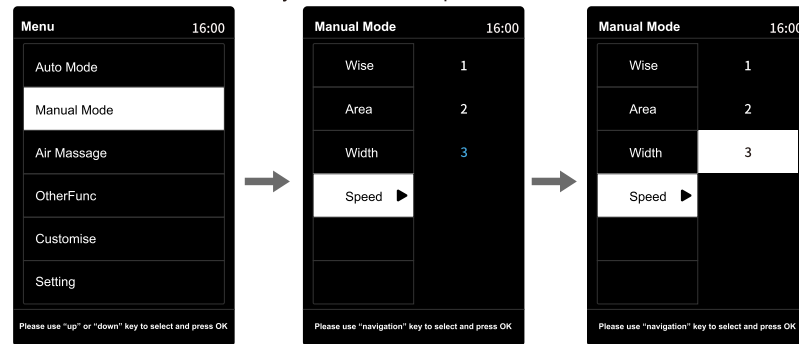

Note:

Width: the width can be adjusted under the massage methods including slapping, finger pressing and tapping, with a total of 3 gears.

Method of Usage

3).Air compression message (menu - air compression message)

- Press the "Menu" key to enter the menu interface, press the "Up" or "Down" key to select air compression message, and press the "OK" key to enter the air compression message interface.
- Air compression message: including upper body air compression, lower body air compression, air compression intensity and other massage functions.
- After entering the air compression message interface, press the "Up" or "Down" key to select any air compression function, then select the sub-menu of this function using the "Right" key, and then press the "OK" key to confirm. Press the "Left" key to return to the previous menu interface.

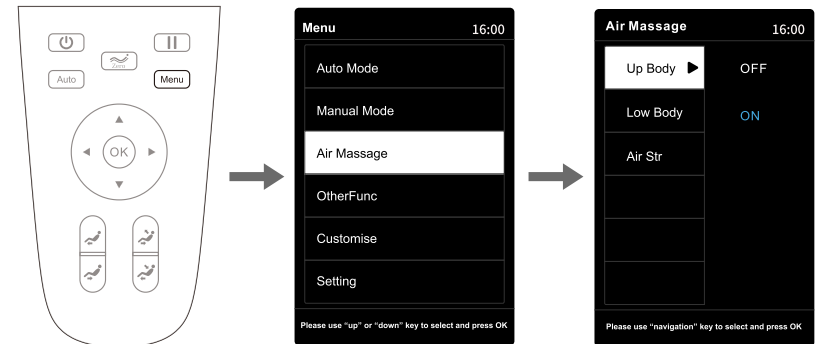

01).Air compression message - upper body air compression

- Upper body air compression: including upper arm air compression, arm air compression, and other air compression massage functions.
- Enter the air compression message interface, press the "Up" or "Down" key to select the upper body air compression message function, enter the upper body air compression sub-menu using the "Right" key to select, then press the "Up" or "Down" key to select to turn on or off the upper body air compression function, and press the "OK" key to confirm. Press the "Left" key to return to the previous menu interface.

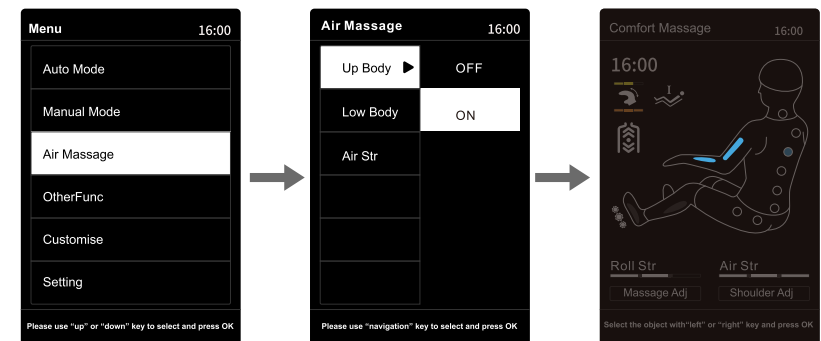

Method of Usage

02).Air compression massage - lower body air compression

- Lower body air compression: including leg air compression, foot air compression and other air compression massage functions
- Enter the air compression massage interface, press the "Up" or "Down" key to select the air compression intensity, enter the air compression intensity sub-menu using the "Right" key to select, then press the "Up" or "Down" key to select any air compression intensity gear, and press the "OK" key to confirm. Press the "Left" key to return to the previous menu interface.



03).Air compression massage - air compression intensity

- Air compression intensity: the intensity can be adjusted in three gears.
- Enter the air compression massage interface, press the "Up" or "Down" key to select the air compression intensity, enter the air compression intensity sub-menu using the "Right" key to select, then press the "Up" or "Down" key to select any air compression intensity gear, and press the "OK" key to confirm. Press the "Left" key to return to the previous menu interface.

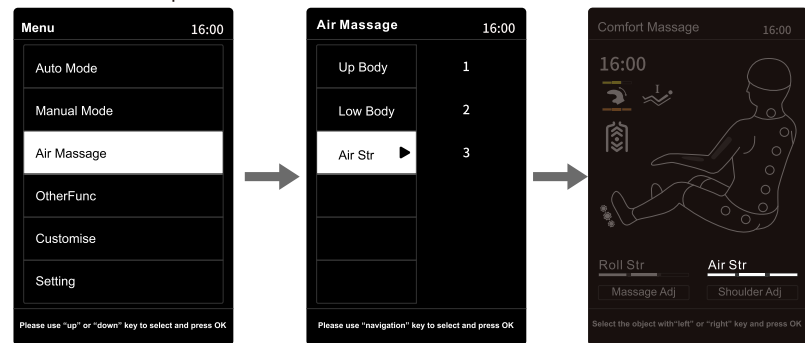

Method of Usage

4).Auxiliary function (menu - auxiliary function)

- Press the "Menu" key to enter the menu interface, press the "Up" or "Down" key to select auxiliary functions, and press the "OK" key to enter the auxiliary function interface.
- Auxiliary functions: including sole roller massage, which is adjustable in 4 states, i.e. off, 1st gear, 2nd gear and 3rd gear, and set to 2nd gear by default when the product is powered on.
- After entering the auxiliary function interface, press the "Up" or "Down" key to select the sole roller massage function, enter the sub-menu of this function using the "Right" key, then press the "Up" or "Down" key to select any roller strength, switch selection, and press the "OK" key to confirm. Press the "Left" key to return to the previous menu interface.

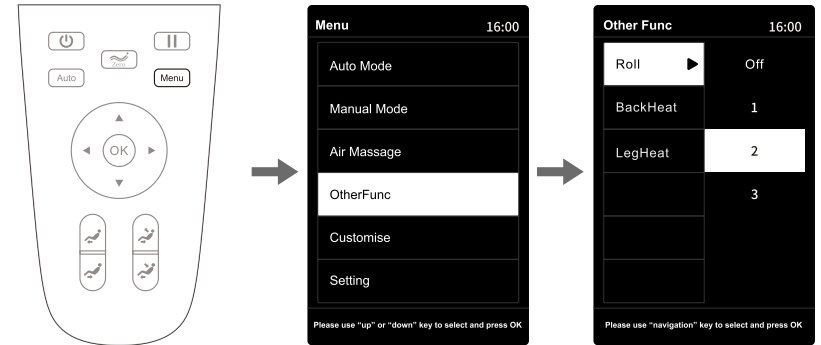

01).Additional function--back heating function

Back heating function: You will feel warm after start heating function 3 mins
When you enter the auxiliary function interface, press "upper" or "lower" button to choose the back heating function. Through "right" button enter to the submenu, then choose "upper" or "lower" button to turn on or off, press "ok" to confirm. Press "left" button to back to the previous menu.



Method of Usage

02).Additional function--calcrest heating function

- Calcrest heating function: You will feel warm after start heating function 3 mins.
- When you enter the auxiliary function interface, press "upper" or "lower" button to choose the calcrest heating function. Through "right" button enter to the submenu, then choose "upper" or "lower" button to turn on or off, press "ok" to confirm. Press "left" button to back to the previous menu.

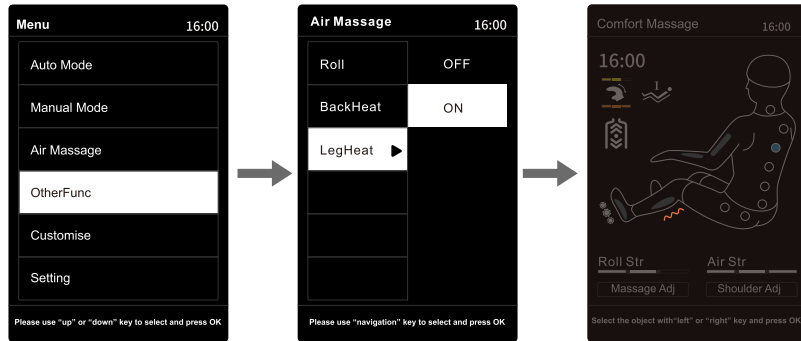

5).Memory storage (menu - memory storage)

- Press the "Menu" key to enter the menu interface, press the "Up" or "Down" key to select the memory storage function, and press the "OK" key to enter the memory storage interface, including storage functions such as storage call and storage save.
- Memory storage includes three functions: storage 1, storage 2 and storage 3.
- After entering the memory storage interface, press the "Up" or "Down" key to select any of storage 1, storage 2 and storage 3, enter the storage or call sub-menu using the "Right" key, then press the "Up" or "Down" key to select, and press the "OK" key to confirm. Press the "Left" key to return to the previous menu interface.
- Storage: Storing the currently running massage program, including massage method, air compression mode and intensity, position and angle of lower leg frame and backrest frame, and other massage functions.
- Call: Calling the previously saved massage program, including massage mode, massage method, air compression mode and strength, position and angle of lower leg frame and backrest frame, and other massage functions.

Method of Usage

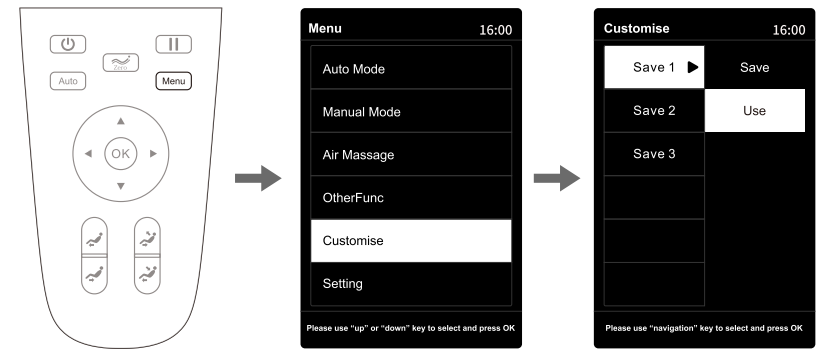

6).Setting function (menu - setting function)

- Press the "Menu" key to enter the menu interface, press the "Up" or "Down" key to select the setting function, and press the "OK" key to enter the setting function interface.
- Setting functions: including Bluetooth, voice control, language, serial number and other setting functions.
- After entering the setting function interface, press the "Up" or "Down" key to select any setting function, then select the sub-menu of this function using the "Right" key, and then press the "OK" key to confirm. Press the "Left" key to return to the previous menu interface.

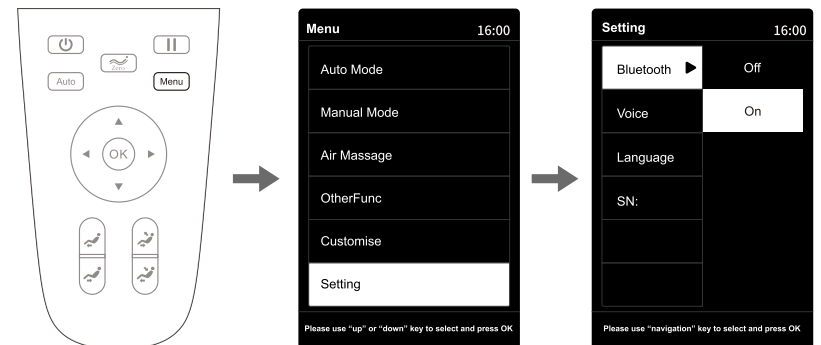

Method of Usage

01).Setting function - Bluetooth

- Bluetooth: Turn on the Bluetooth function of the massage chair to connect the sound source device with Bluetooth function (such as mobile phone, MID tablet, etc.). After pairing and connecting with the Bluetooth module of the massage chair, the music played by the sound source device can be wirelessly transmitted to the sound system of the massage chair through Bluetooth for music playing.
- After entering the setting function interface, press the "Up" or "Down" key to select the Bluetooth function, enter the Bluetooth function sub-menu using the "Right" key to select, then press the "Up" or "Down" key to select to turn on or off the Bluetooth function, and press the "OK" key to confirm; press the "Left" key to return to the previous menu interface.

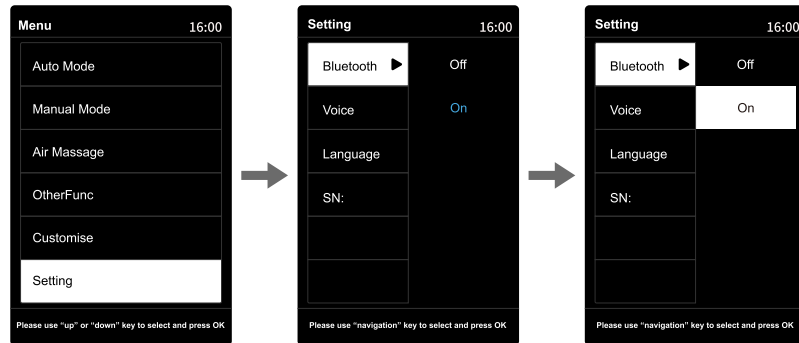

02).Setting function - voice control

- Voice control: intelligent voice control function (this function has memory, i.e. if selected, it is still the function selected when the product is restart after power failure); Note: When the intelligent voice control is turned off, voice wake-up cannot be performed.
- After entering the setting function interface, press the "Up" or "Down" key to select the voice control function, enter the voice control function sub-menu using the "Right" key to select, then press the "Up" or "Down" key to select to turn on or off the voice control function, and press the "OK" key to confirm; press the "Left" key to return to the previous menu interface.

Method of Usage

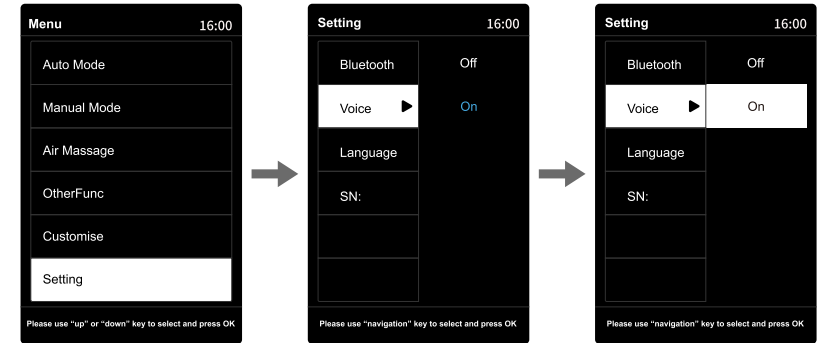

03).Setting function - language

- Language: including Simplified Chinese and English.
- After entering the setting function interface, press the "Up" or "Down" key to select the language function, enter the language function sub-menu using the "Right" key to select, then press the "Up" or "Down" key to select any language function, and then press the "OK" key to confirm; press the "Left" key to return to the previous menu interface.

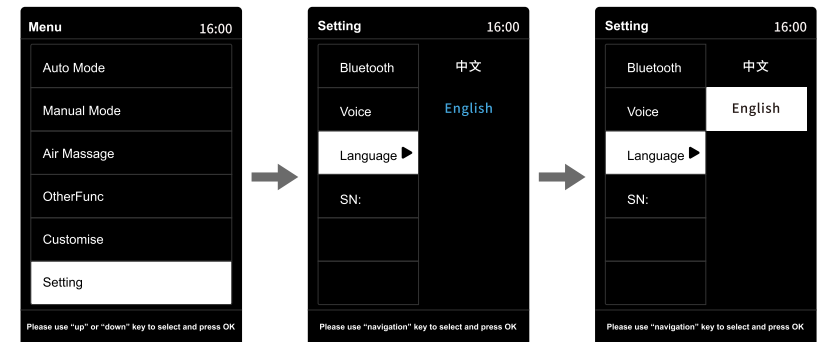

04).Setting function - serial number

- Serial number: displaying current device information
- After entering the setting function interface, press the "Up" or "Down" key to select the serial number, and press the "Left" key to return to the previous menu interface.

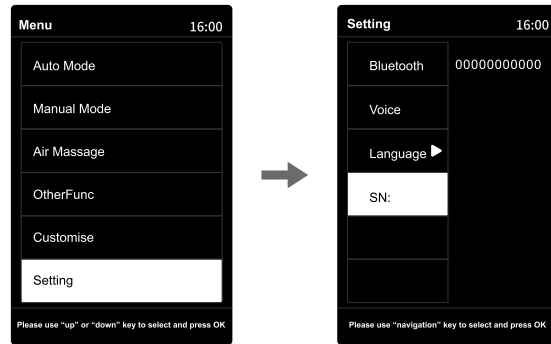

7). Message adjustment

- In the information interface, press the "Left" or "Right" key to select the message adjustment button, and press the "OK" key to enter the message adjustment interface.
- Message adjustment includes three message adjustment functions for selection, i.e. 3D intensity, air compression intensity and time adjustment.
- After entering the message adjustment interface, press the "Up" or "Down" key to select any message adjustment function, then enter the message adjustment sub-menu using the "Right" key to select, then press the "Up" or "Down" key to select the desired message adjustment gear, and press the "OK" key to confirm. Press the "Left" key to return to the previous menu interface.

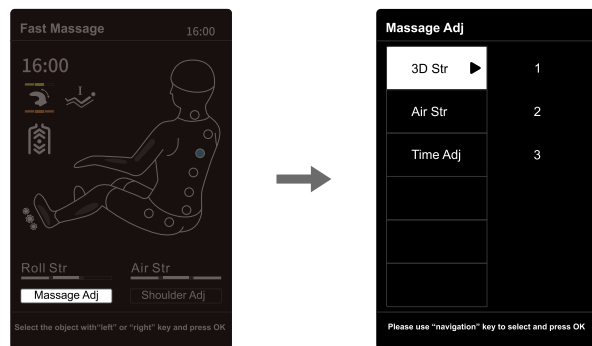

Function	Description
3D intensity	Neck, back, waist, hip massage intensity adjustment, with a total of 3 gears.
Air compression strength	The strength can be adjusted in 3 gears.
Time adjustment	4 modes are available, i.e. +10 minutes, +5 minutes, -5 minutes and -10 minutes.

Note:

- Depending on the remaining massage time, when the displayed time is not enough to add or subtract a certain time, the operation will not be displayed (the upper limit of time display is 40 minutes). For example, if the displayed time of the manual controller is 39 minutes, the adjustment range of massage time is -5 minutes or -10 minutes (+10 minutes and +5 minutes cannot be displayed).
- Among them, the adjustment of air compression intensity can only be used when the air compression function or the automatic function is turned on (please refer to page 21 of this manual for details on the mode for turning on the air compression function).

5.Zero-gravity key



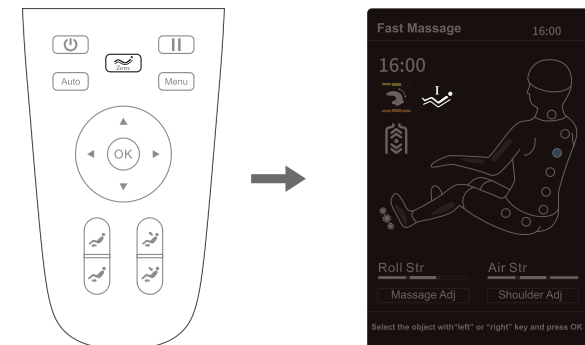

- Zero-gravity key: each time the key is pressed, the position of the lower leg frame and backrest frame will be automatically adjusted to the zero-gravity position, with a total of three zero-gravity lying modes in cyclic switching.



Function	Description
	Zero-gravity key: each time the key is pressed, the position of the lower leg frame and backrest frame will be automatically adjusted to the zero-gravity position, with a total of three zero-gravity lying modes in cyclic switching.

Method of Usage

6. Lying angle adjustment key

Function	Description
	Lower leg frame ascending key: press and hold this key to slowly rise the lower leg frame, and release it to stop rising.
	Lower leg frame descending key: press and hold this key to slowly lower the lower leg frame, and release it to stop lowering.
	Linkage sit-up key: press and hold this key to slowly rise the backrest frame while slowly lowering the lower leg frame, and release it to stop rising of the backrest frame or lowering of the lower leg frame.
	Linkage lying key: press and hold this key to slowly lower the backrest frame while slowly rising the lower leg frame, and release it to stop lowering of the backrest frame or rising of the lower leg frame.

Method of Usage

III. Voice Control Mode

- When the massage chair is turned on or in standby mode, the sound "Hi Alice" or "Hey Alice" will be produced to enable the voice control function.
- After such function is enabled successfully, the massage chair will reply "I am here." At this moment, once a corresponding voice control entry to be implemented is given within six seconds, the corresponding voice control function can be performed after a reply is received from the massage chair; if no correct voice control entry is given within six seconds, the voice control function automatically will be off automatically and needs to be enabled again.
- Note: When waking up the voice control function, please use English, the speech rate is moderate, Voice commands should be follow up the Voice entry.

Voice Control Entry		
Entry: "hi Alice". Answer: I am here.		
No.	Voice control entry	Answer entry
1	Massage on	Answer: Ok, massage on
2	Massage close	Answer: Ok, massage close
3	Comfort Massage	Answer: Ok, comfort massage
4	Relax massage	Answer: Ok, relax massage
5	Full body massage	Answer: Ok, full body massage
6	Neck and shoulder massage	Answer: Ok, neck and shoulder massage
7	Back and waist massage	Answer: Ok, back and waist massage
8	Stretch massage	Answer: Ok, stretch massage
9	Fixed massage	Answer: Ok, fixed massage
10	Change the other mode	Answer: Ok, change the other mode
11	Go little down	Answer: Ok, go little down
12	Go little up	Answer: Ok, go little up
13	Open the air pressure	Answer: OK, open the air pressure
14	Close the air pressure	Answer: OK, close the air pressure
15	Up the seat position	Answer: Ok, Up the seat position
16	Down the seat position	Answer: Ok, down the seat position
17	Stop adjustment	Answer: Ok, stop adjustment

Method of Usage

IV. End massage

- During the massage process, press the power on/off key to immediately turn off all massage functions, reset the backrest frame and the lower leg frame, or when the massage timing time arrives, all massage functions will be automatically turned off, with the backrest frame and the lower leg frame not reset.

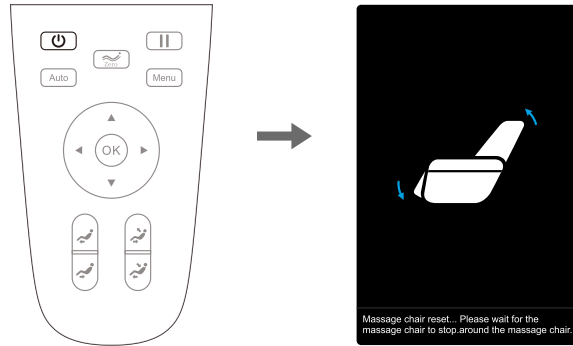

- Shut off the power supply of this product, as shown in the attached figure (Power Shut-off Diagram of the Product).

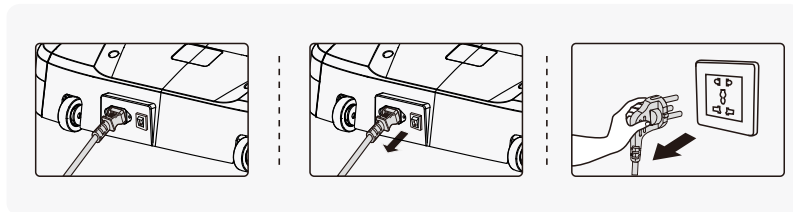

- 1 Power Shut-off Diagram of the Product
- 2 Disconnection Diagram
- 3 Unplugging Diagram

V. Operation Instructions for Bluetooth Speaker Play

1. Enter the smart device main menu. Open "Settings" and select the "Bluetooth" option. Open "Bluetooth", and Bluetooth will automatically "Search for a New Bluetooth Device".
2. The smart device will search for the corresponding Bluetooth model (e.g. IMCM-XXXX). Click the "Match" button. If you are asked whether to match with the device, you just select "Match" to complete matching.
3. Turn on "Music Player" in the smart device and select the song to play.

Method of Usage

VI. Instructions for installation of lower leg

1. After connecting the lower leg and the air tube on the massage chair with the wire harness, untie the fixed pipeline belt and insert the connecting part into the seat frame (Fig. 1).
2. Sleeve the lower leg fixing block on the round tubes on the left and right sides of the lower leg (Fig. 2).

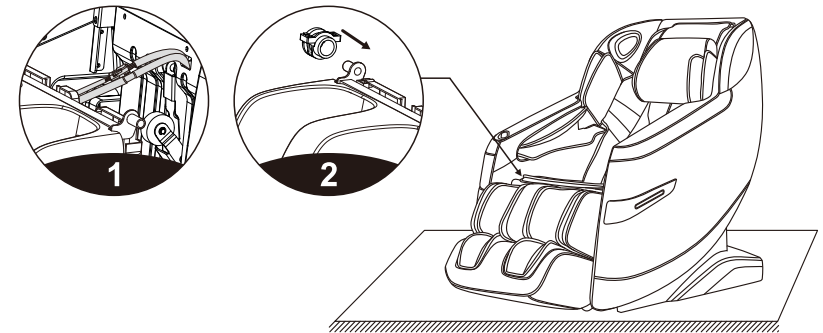

3. Hang the lower leg sleeved with the fixing block on the hook of the massage chair seat frame (Fig. 3).
4. Fasten the lower leg on the massage chair with 4 M4 screws (2 on the left and 2 on the right). Check whether there is any abnormality in the up-and-down turning and whether the pipeline is folded. Then the lower leg installation is completed (Fig. 4).

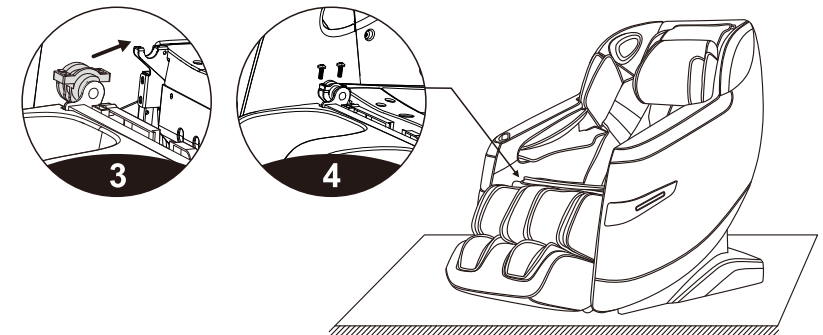

Method of Usage

VII. Instructions for Removal and Use of Head Cushion and Backrest

- The use of the head cushion can reduce the intensity of kneading massage on the neck and shoulders. You can decide whether to use the head cushion according to your own needs (the head cushion is recommended). The backrest and the back cushion are connected by a zipper (1). The head cushion and the backrest are connected by a Zipper (2).

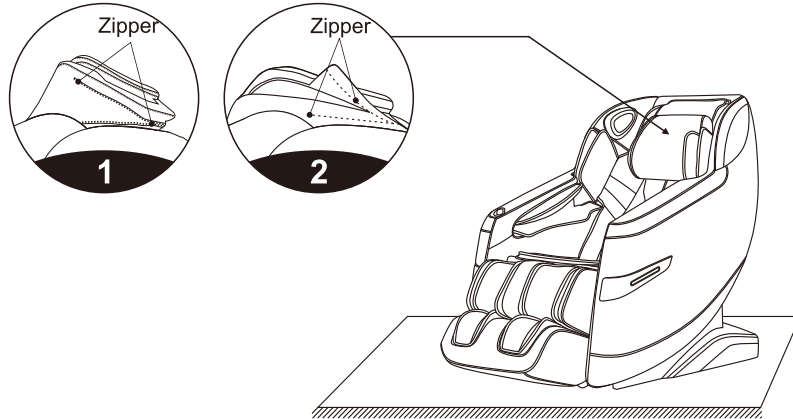

VIII. Floor Protection

- The prolonged heavy pressure on the massage chair may cause scratches on the floor. Thus, put a carpet or cushion on the floor where the massage chair is placed to avoid this damage.

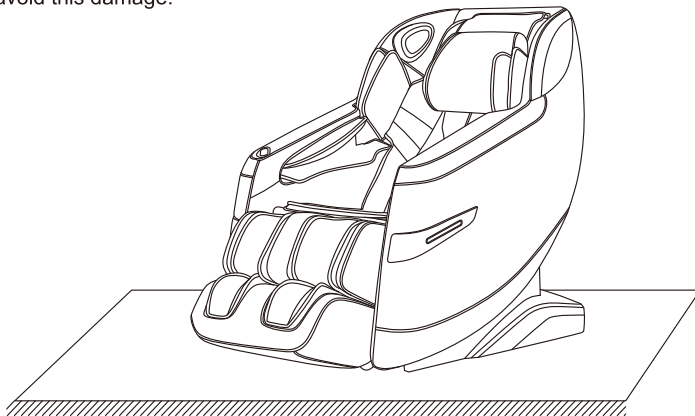

Note: Do not move the massage chair with its wheels on the rough ground or in a narrow space. At least two persons are required to lift it. During lifting, take the legrest sealing plate and backrest cover grooves as the acting points. (Do not lift the armrest directly.)

Method of Usage

IX. Instruction for movement

- Make sure that all the wires are pulled away from the massage chair surface; then press the backrest down to a certain angle (with the center of gravity resting on the wheels), you can push the massage chair forward with hands, move it to a suitable position and gently restore it to the normal angle. (Note: During movement, you must turn off the power button first and then unplug the power cord and the remote controller connection wire.)

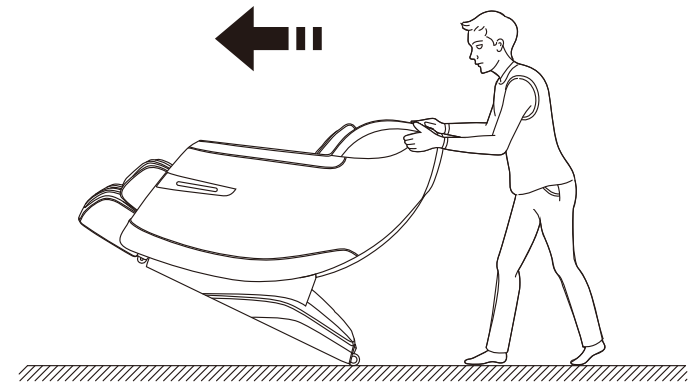

Warning : The rear moving wheels of the massage chair are only suitable for short-distance and slow movement. For long-distance transportation, please use other auxiliary moving tools to move this massage chair!

Product Specification

Model: Titan 3D Quantum

Name: Massage Chair

Rated voltage: 110-120V~ 60Hz
220-240V~ 50Hz/60Hz

Rated power:90W

Rated time: 20min

Safety structure: Class I

Material description: PVC, PA, steel parts, electric and electron components

MATERIAL	PU	LEATHER	CLOTH	WOOD